

High-definition displays of brain activity give
access to order parameters that underlie
epileptic seizures

Walter J Freeman

University of California at Berkeley

<http://sulcus.berkeley.edu>

International Workshop on Advanced
Epilepsy Treatment (CADET 2009)

“Consortium of Advanced
Epilepsy Treatment”

28-30 March 2009

Kitakyushu, JAPAN

Complex Partial Seizure

- Various known as ‘psychomotor epilepsy’, ‘temporal lobe seizure’, ‘petit mal epilepsy’, and ‘fugue state’
- Diagnosed by 3/second spike and wave in EEG
- Accompanied by loss or alteration of consciousness, inattention (*‘absence’*), twitching of lips and eyelid, salivation (drooling), lasting seconds up to a minute
- Commonly follows birth injury to the temporal lobe cortex of the limbic system

How can we base treatment on knowledge of neurodynamics?

The Limbic System

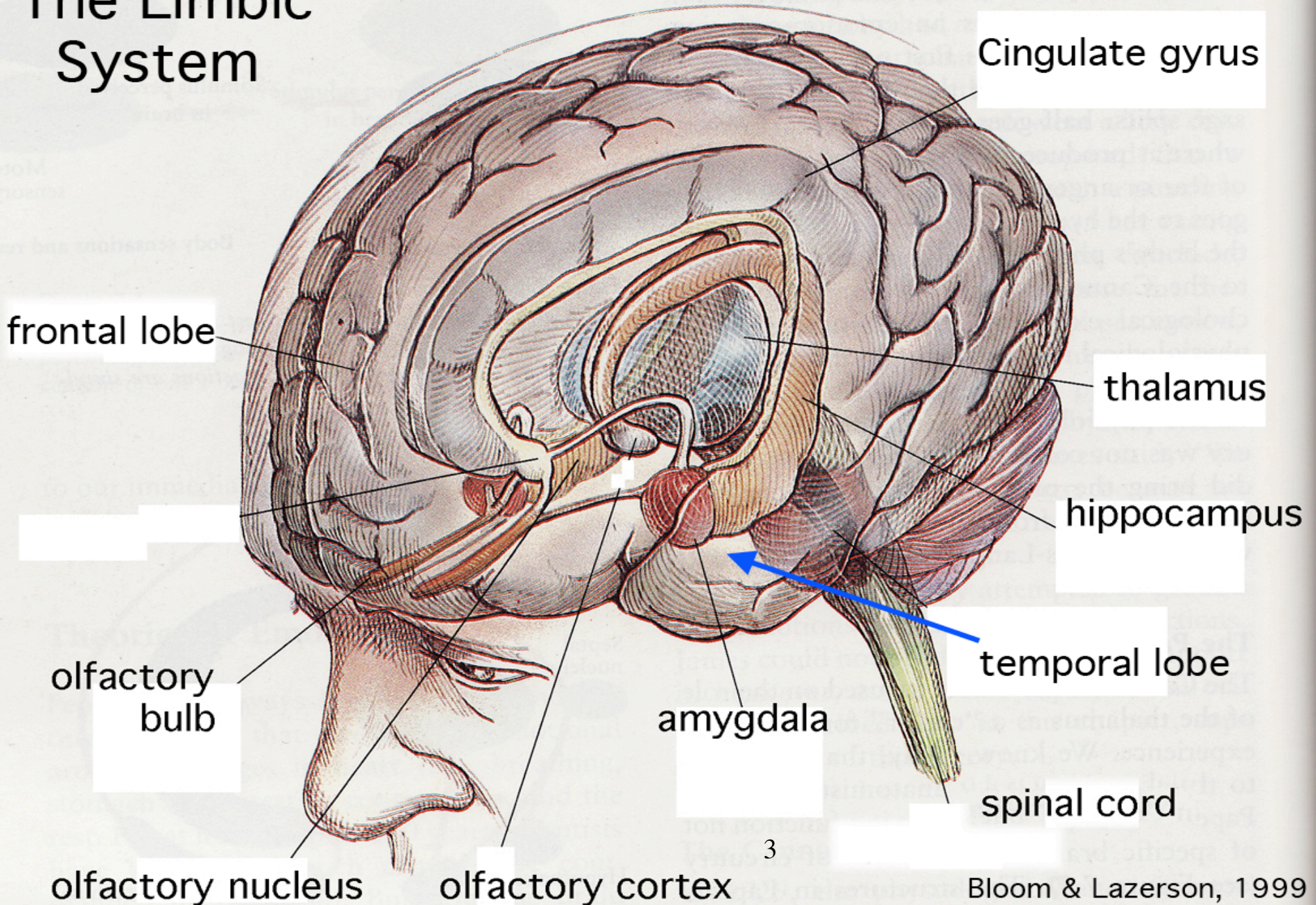

stimulus onset: 40/second pulses

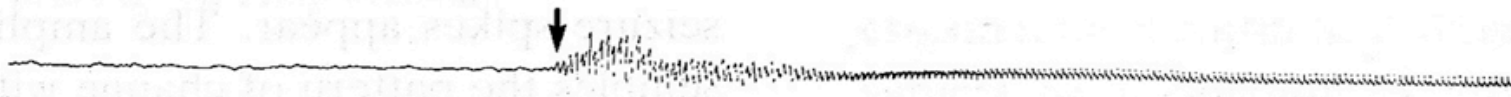

offset unstable equilibrium

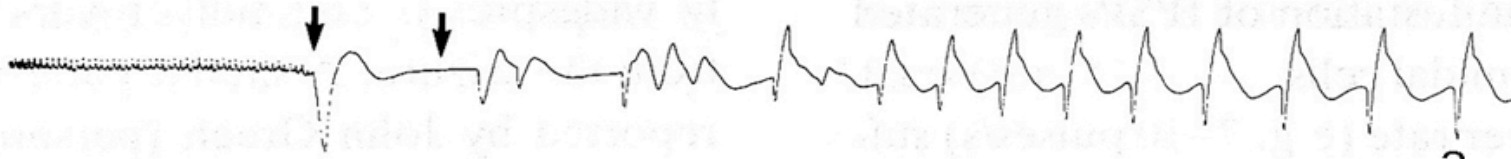

2 mv
0.2 sec

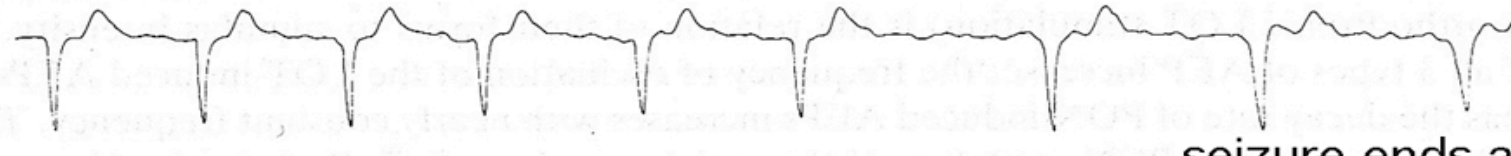
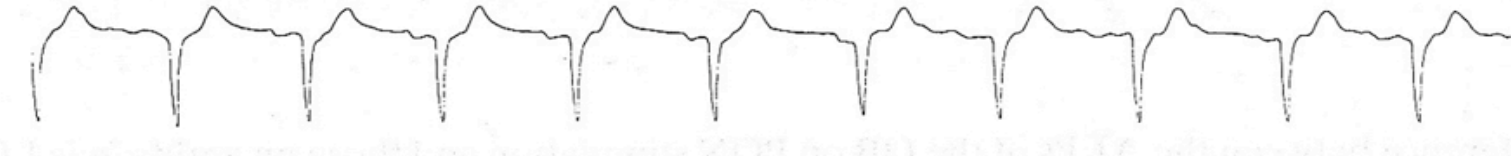
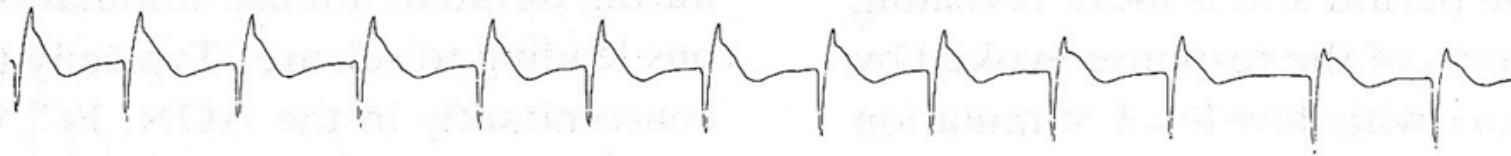

seizure ends abruptly

Stability and Instability

- An epileptic seizure results from a state transition due to a breakdown in normal stabilization.
- To understand the mechanism, it is necessary to know how brains normally stabilize their active states.
- The background “spontaneous” activity of brains comes from mutual excitation of excitatory neurons.
- The activity level is stabilized by the thresholds and refractory periods of action potentials, not by inhibition.
- Excess inhibitory bias causes the instability in this seizure.

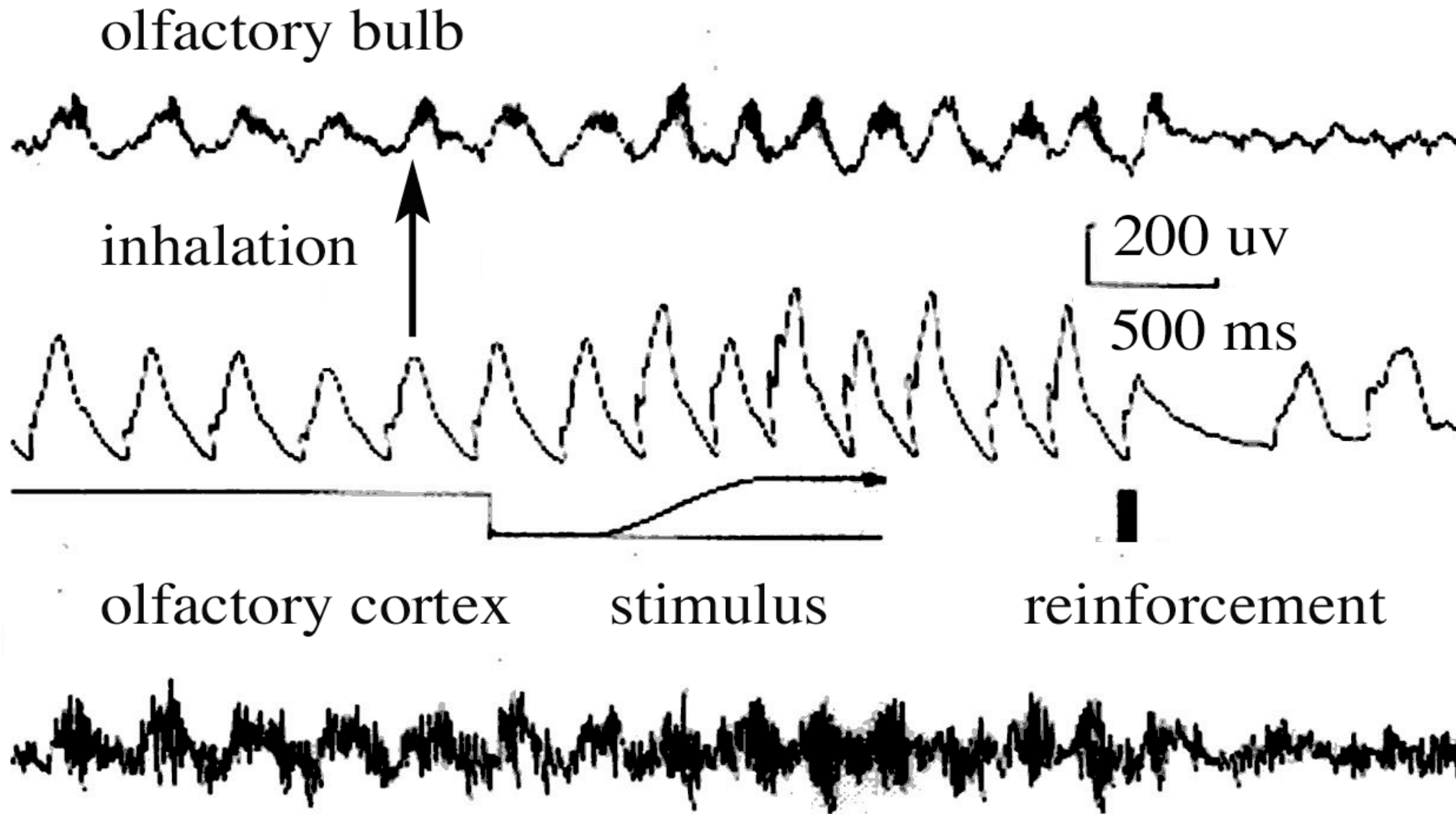

Normal olfactory EEG: each inhalation destabilizes the system.

EEG (100 msec)

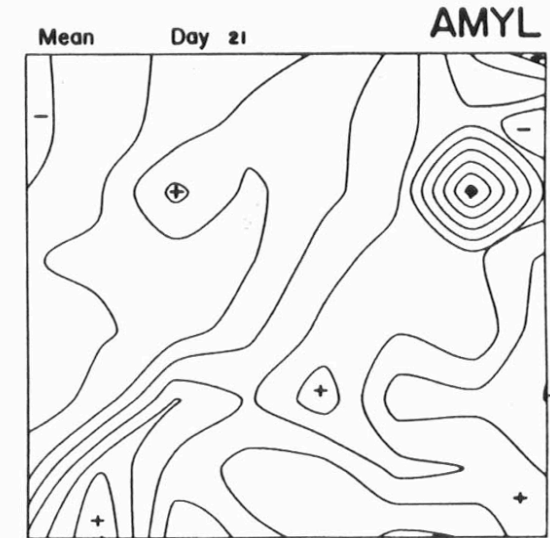
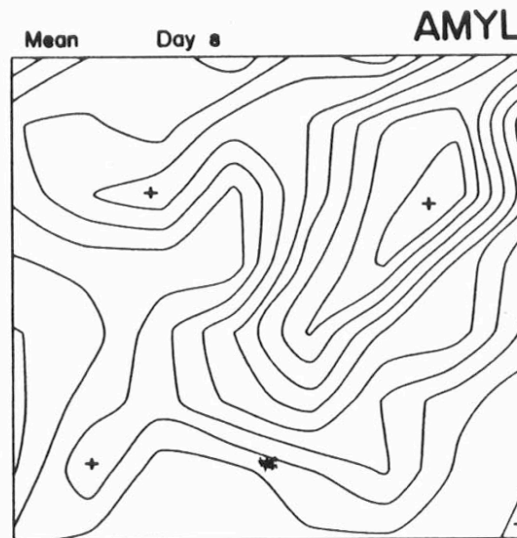
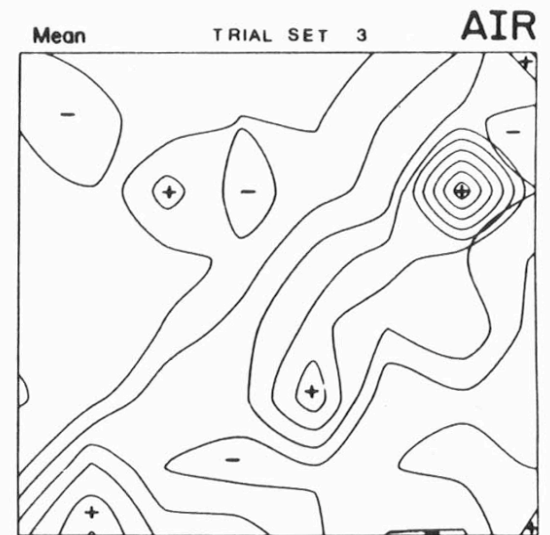
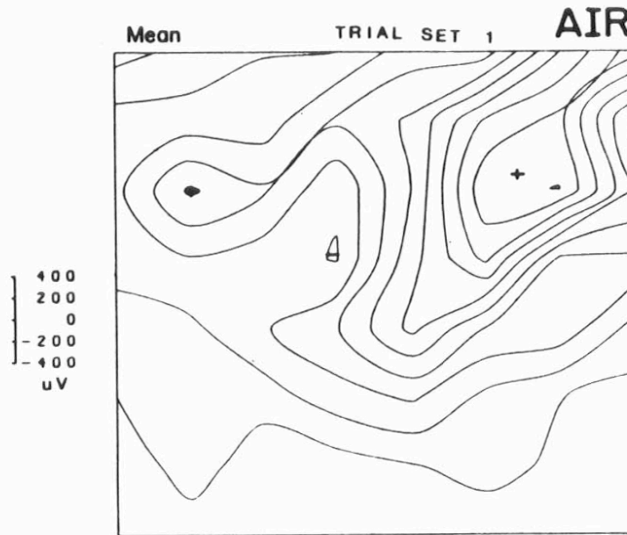
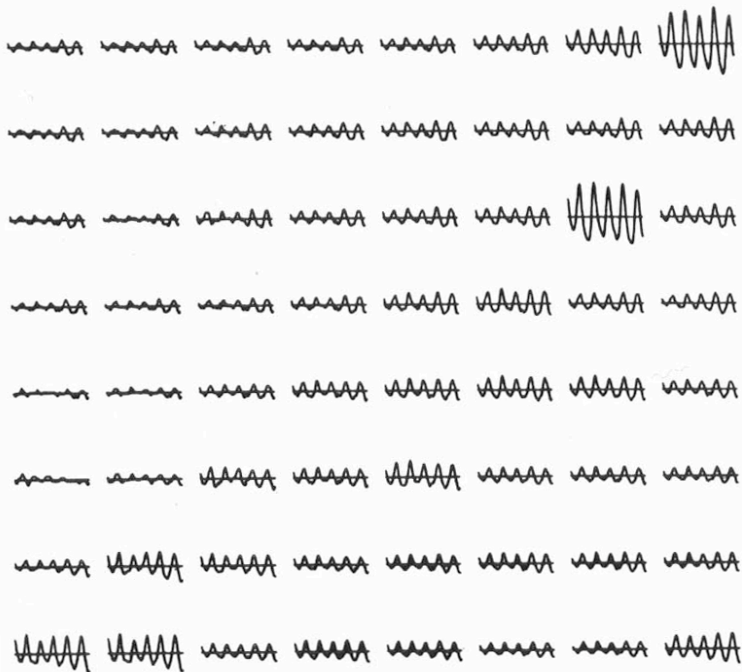

Each new pattern of neural activity occupies the whole bulb. It reflects knowledge, not information.

From Freeman and Schneider, 1978

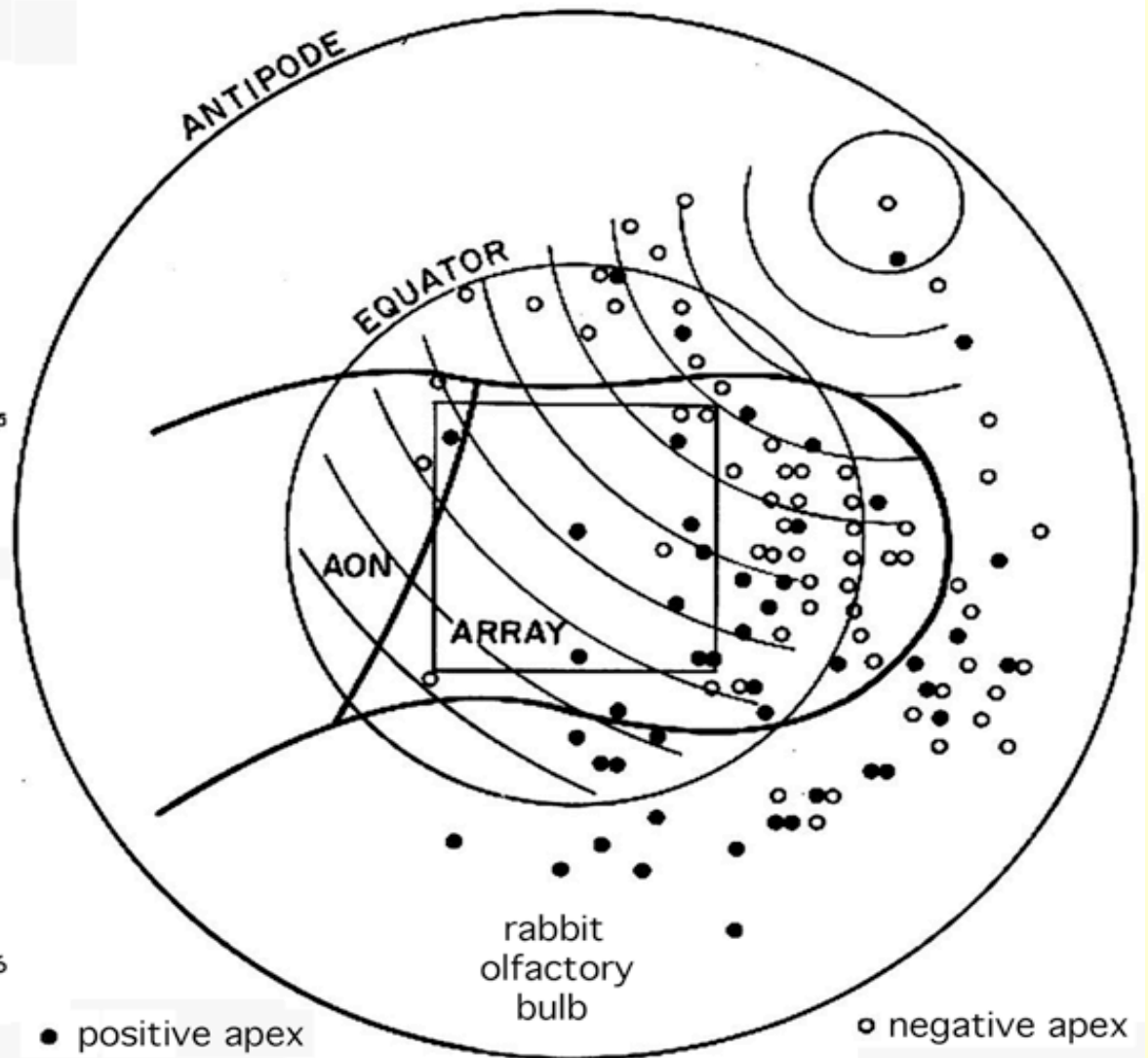
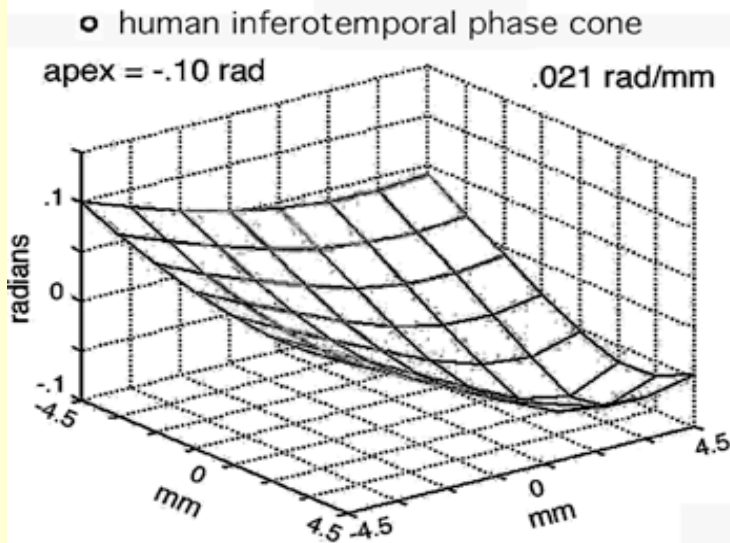
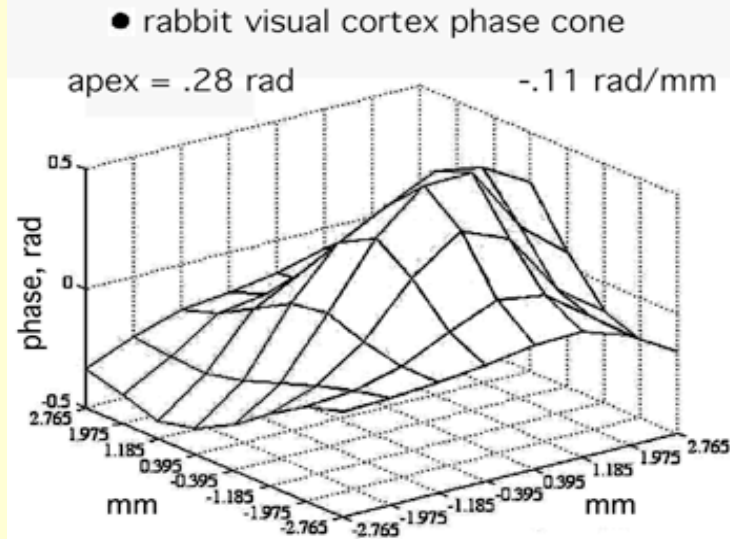

Inset rectangle is an 8x8 array. Circles are bulbar surface. Each dot is the apex of a phase cone (arcs) with phase lead ● or phase lag ○ (120 frames).

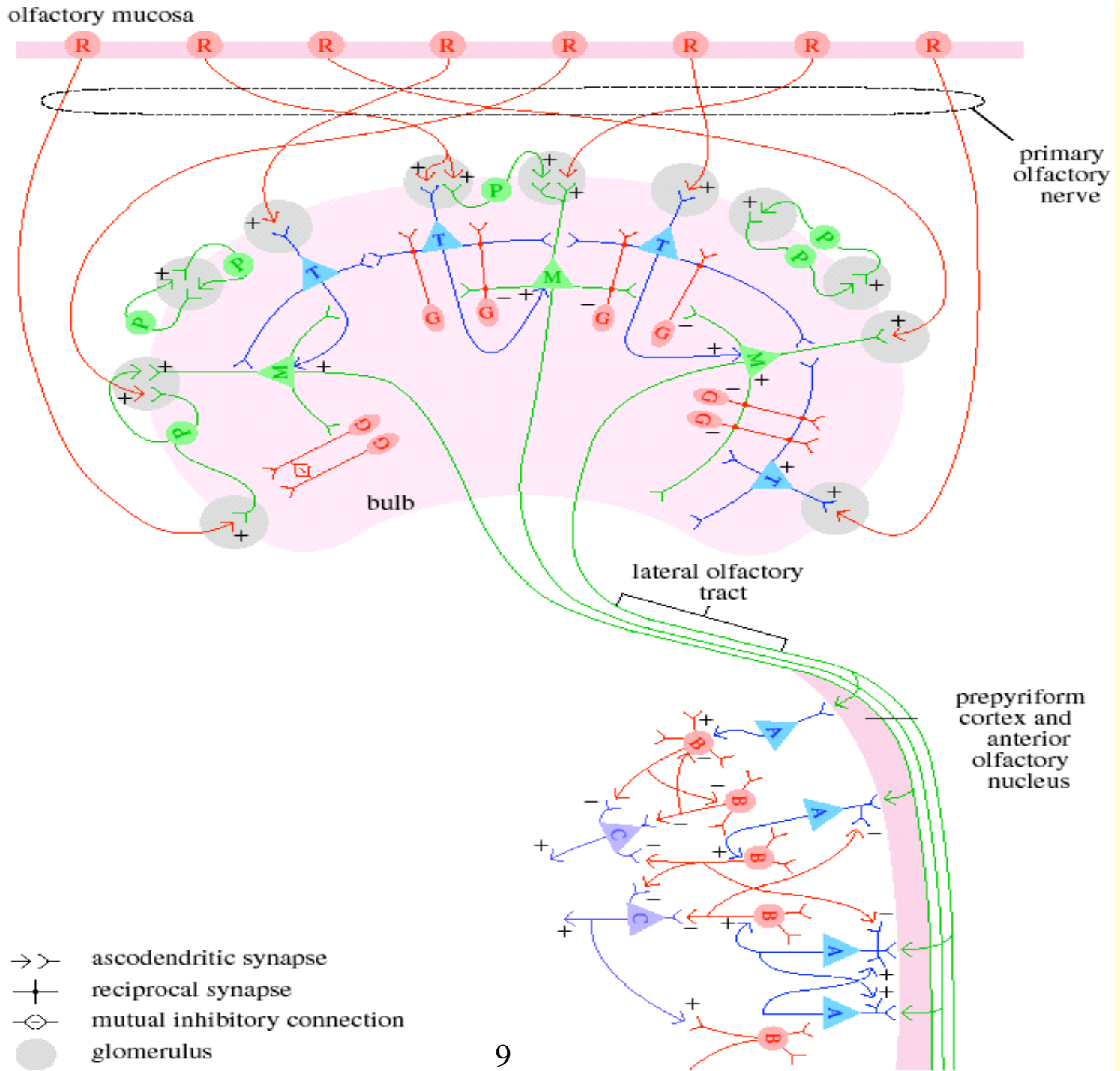

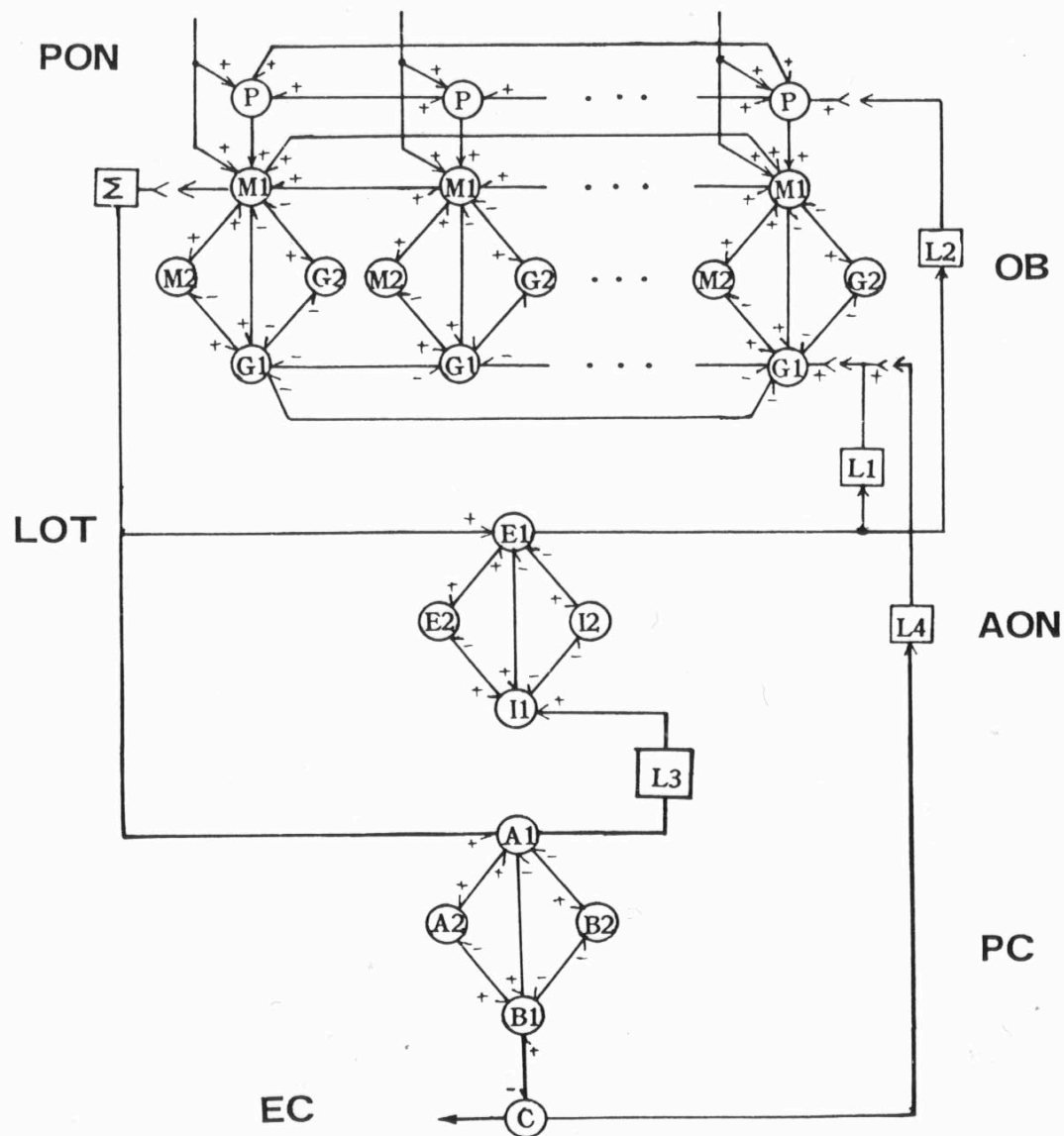

The circles represent neural populations - **KO sets**.

Interactive neurons form **KI sets** in positive feedback that gives the “spontaneous” activity.

KII negative feedback among excitatory and inhibitory cells gives the gamma oscillations.

Positive & negative feedback with long distributed delays in the **KIII set** generates the aperiodic EEG. It is controlled by a **nonconvergent attractor** in cortical state space: “chaos”.

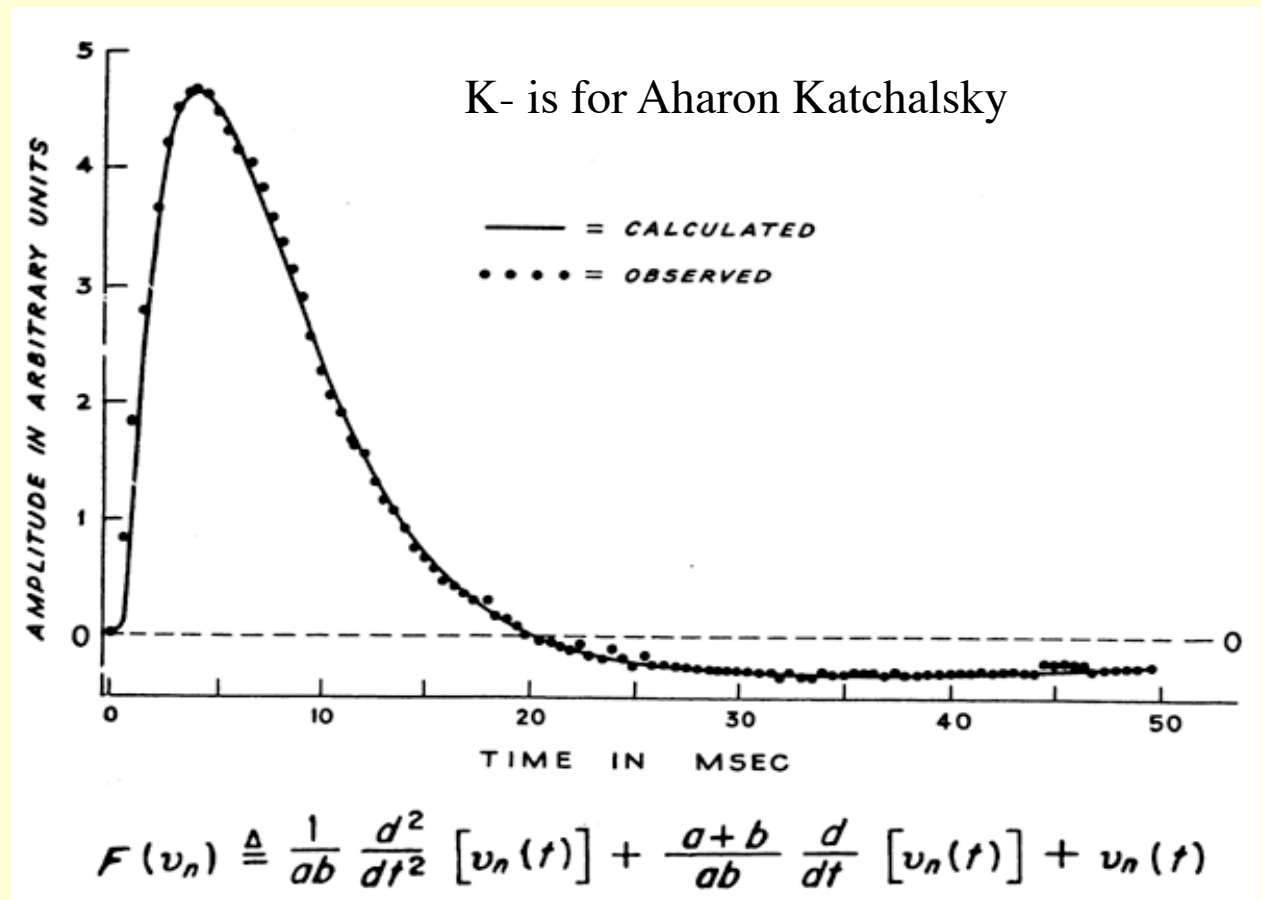
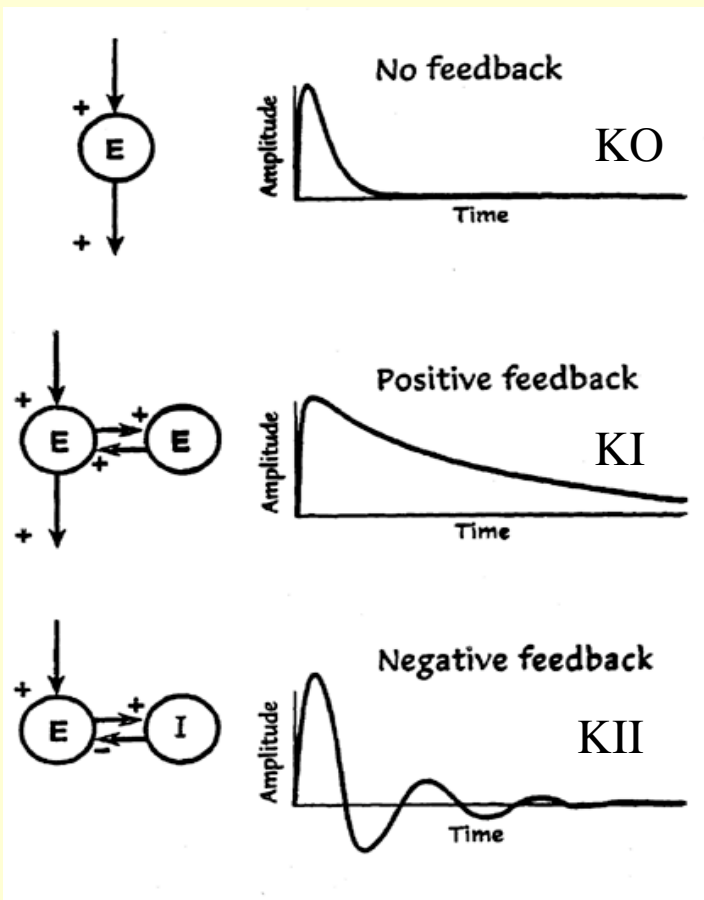

The “open loop” evoked potential is derived by single shock electrical stimulation of the olfactory tract in animals under deep anesthesia, which suppresses ‘spontaneous’ electrical activity in bulb and cortex.

Feedback gain, K_{ee} , in KI sets, is the cortical *control parameter* in learning.

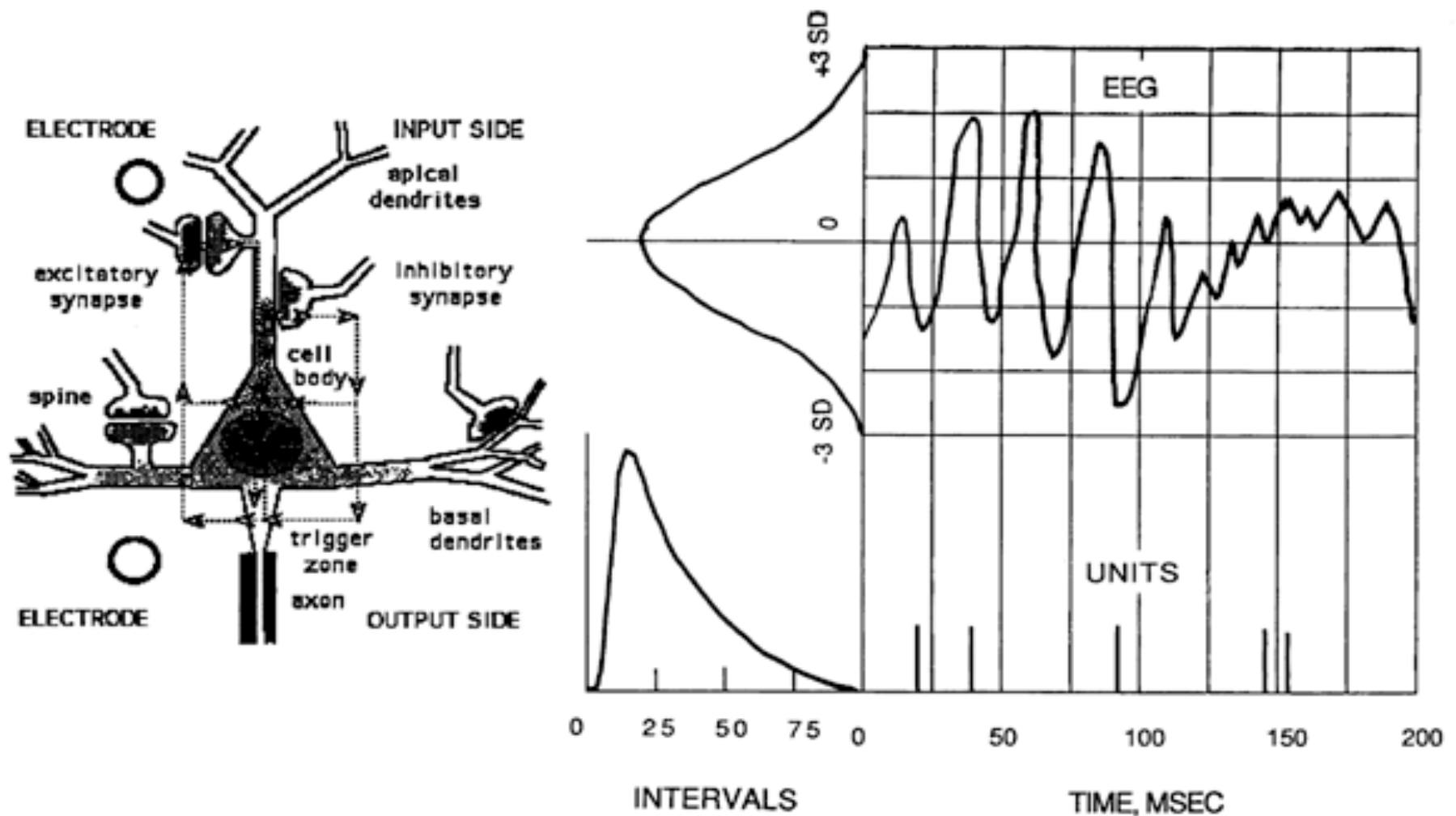

The same current that controls unit firing causes the EEG, but only with summation over the neighborhood - a mesoscopic variable.

The EEG is a measure of the *order parameter* of cortical dynamics.

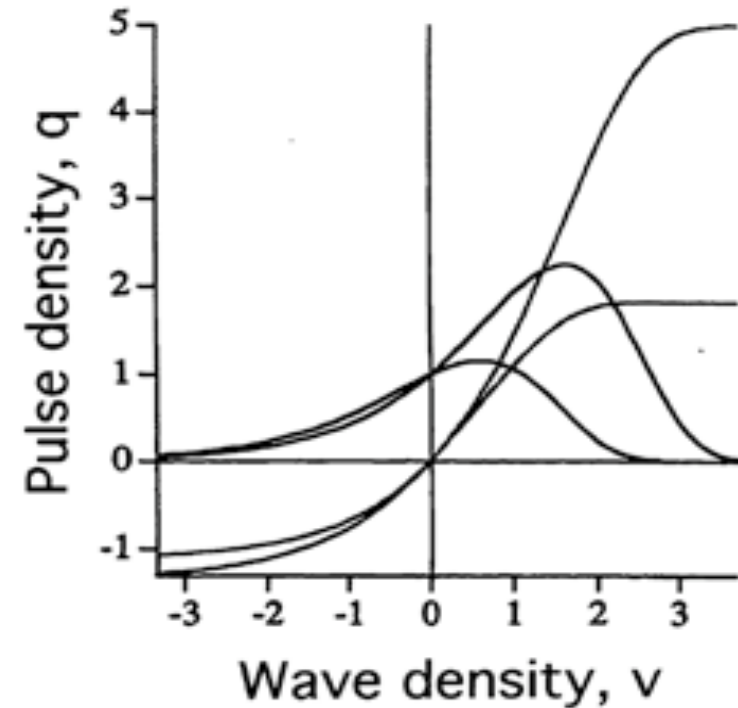
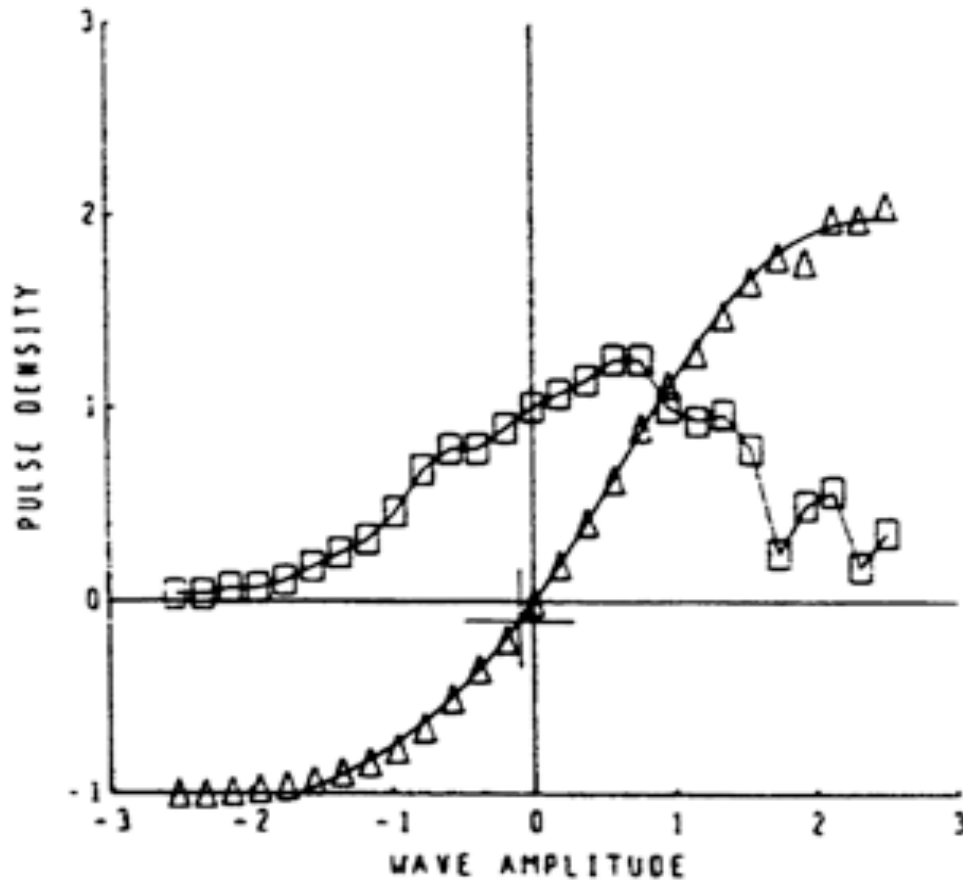

$$q = \exp\left[-\left(e^v - 1\right) / Q_m\right]$$

$$dq/dv = \exp\left[v - \left(e^v - 1\right) / Q_m\right]$$

$$v_{\max} = \ln(Q_m)$$

The equation is derived from the Hodgkin-Huxley equations. The nonlinear forward gain, given by the derivative, is the basis for the destabilization of the bulb by receptor input with inhalation, inducing oscillatory bursts.

The asymmetry of nonlinear gain is crucial for phase transitions in perception.

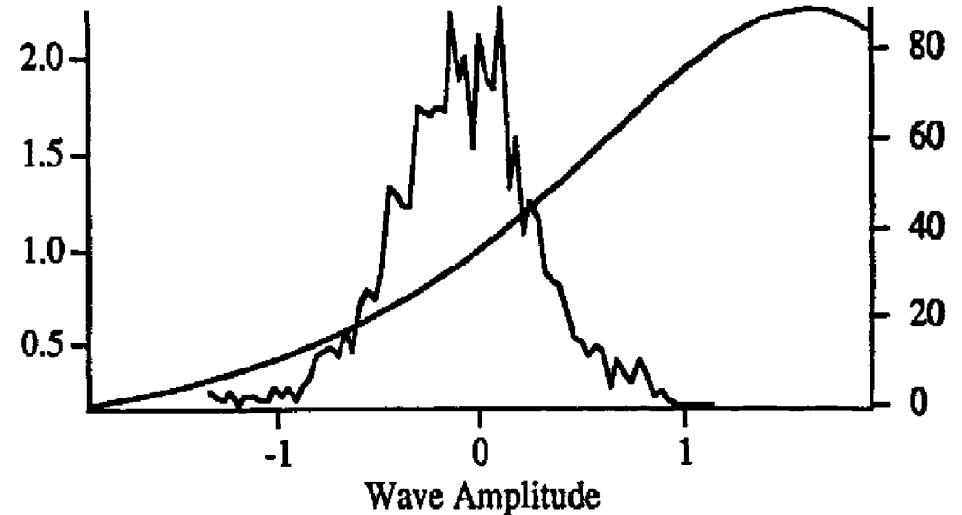
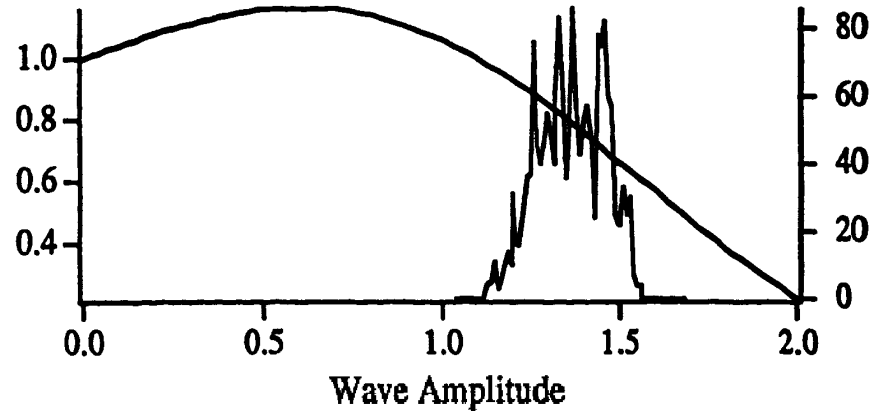
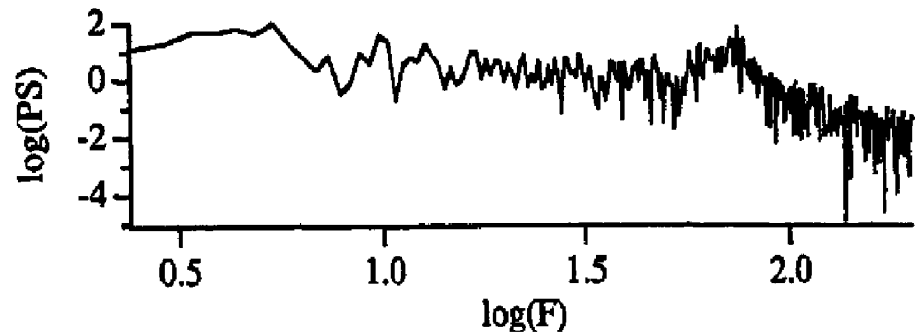
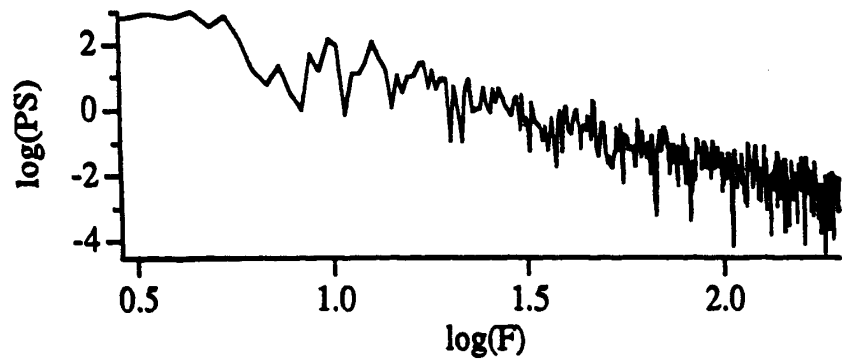

The periglomerular population is stabilized at a non-zero point attractor. Its spectrum approximates $1/f^\alpha$, $\alpha = 2$, called Brown noise.

The mitral-granule populations are stabilized at a limit cycle attractor. Their spectrum has a broad peak near 40 Hz.

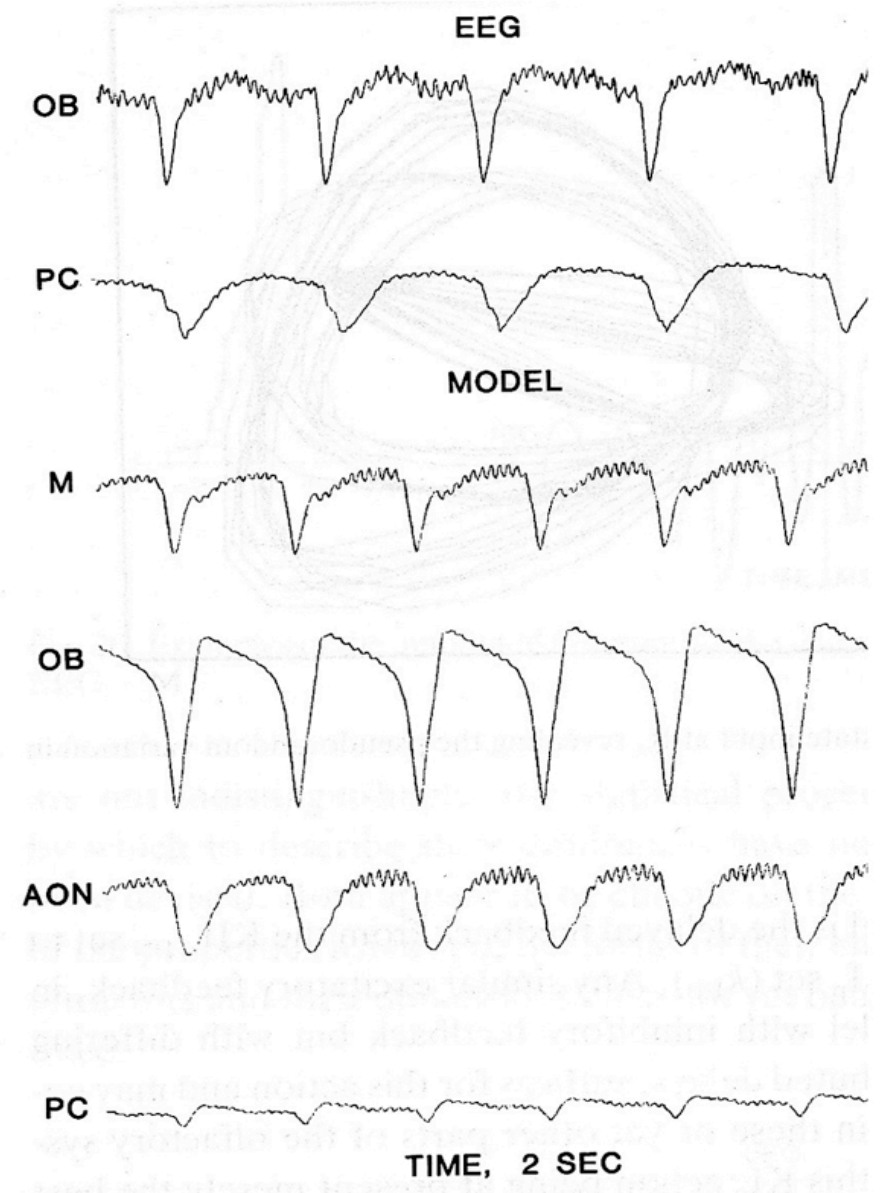
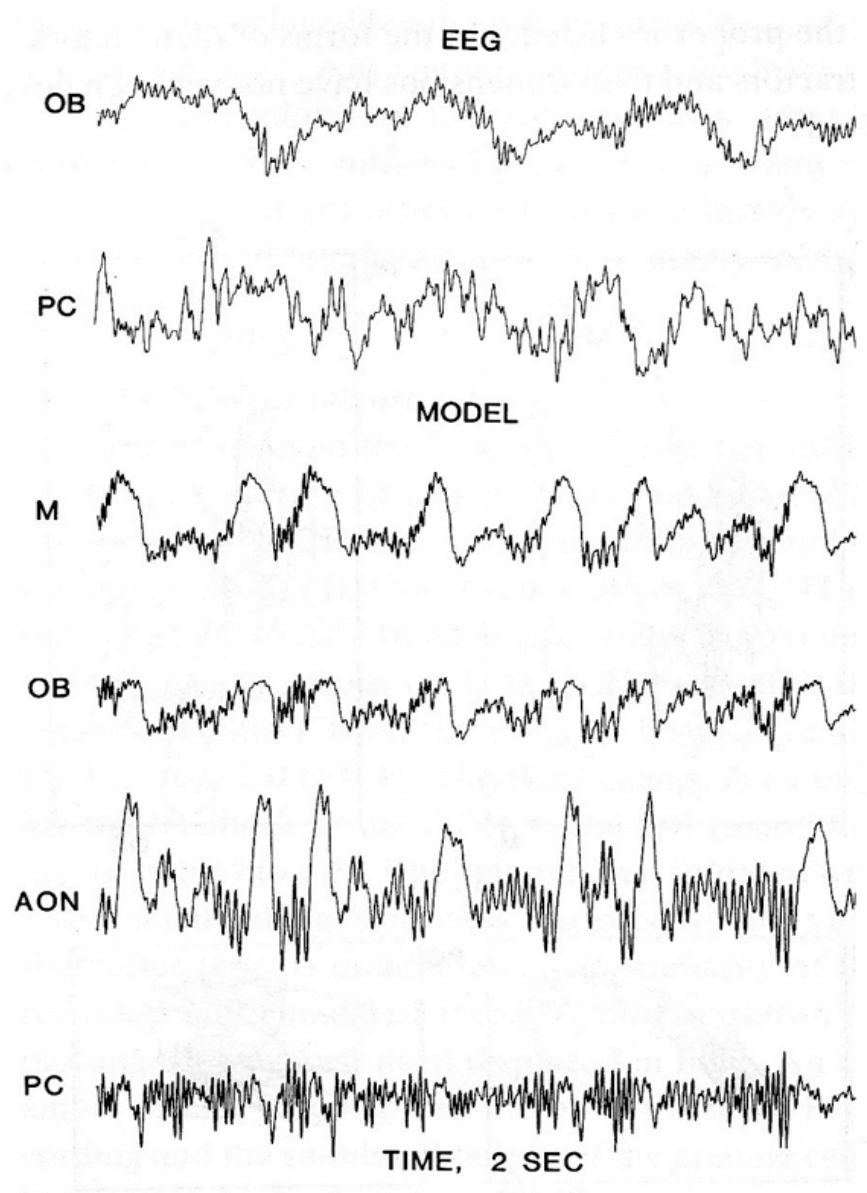

Comparison of ECoG recordings with simulations: normal vs. seizure

- How is background activity generated?
 - How is it stabilized?
 - “Spontaneous” activity arises by mutual excitation in populations in positive feedback.
 - It is stabilized by refractory periods, not by inhibitory feedback.

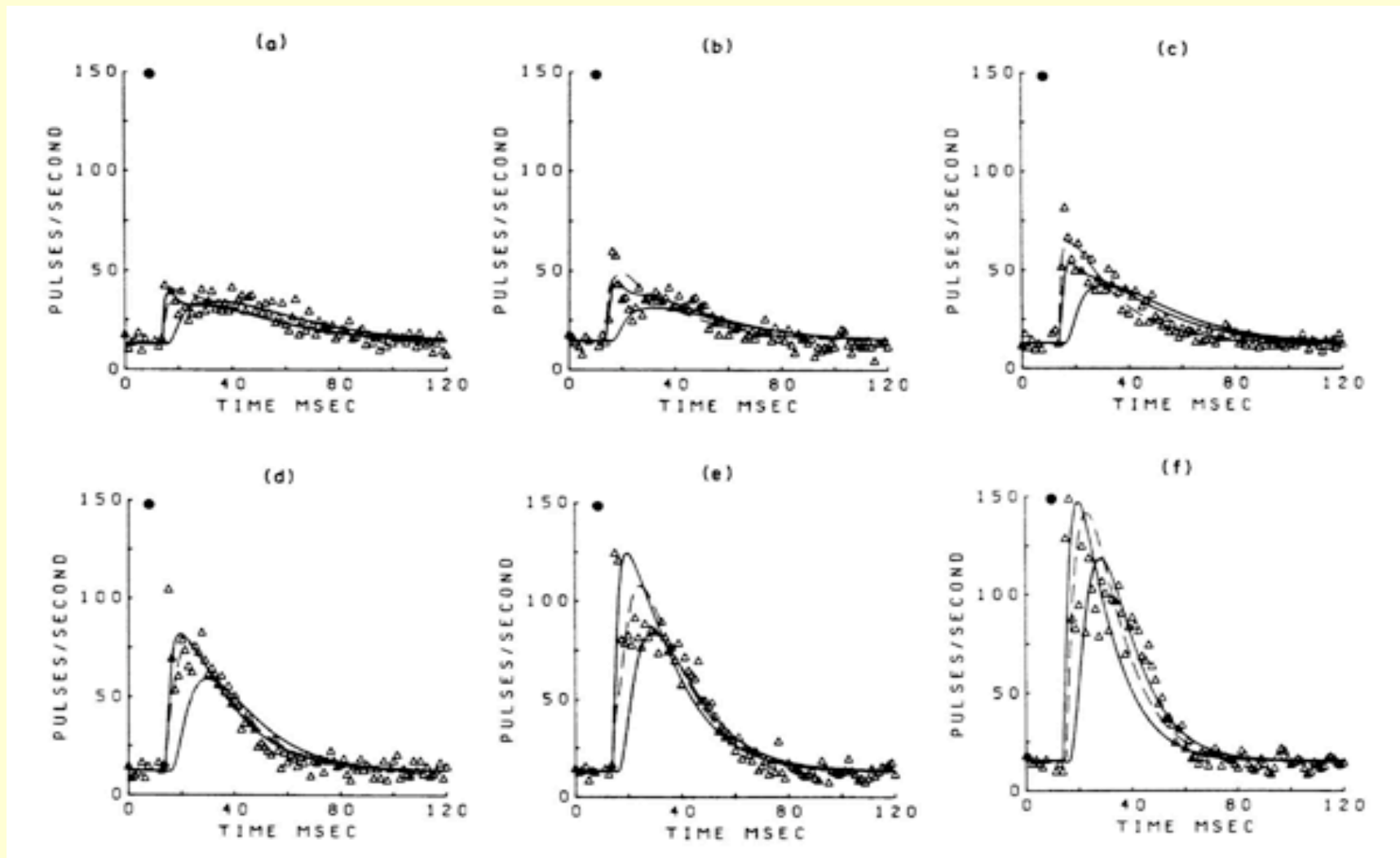

The impulse response of the periglomerular neurons is non-oscillatory. The peak of the PSTH rises with stimulus intensity; decay rate increases.

Periglomerular threshold reveals a non-zero point attractor

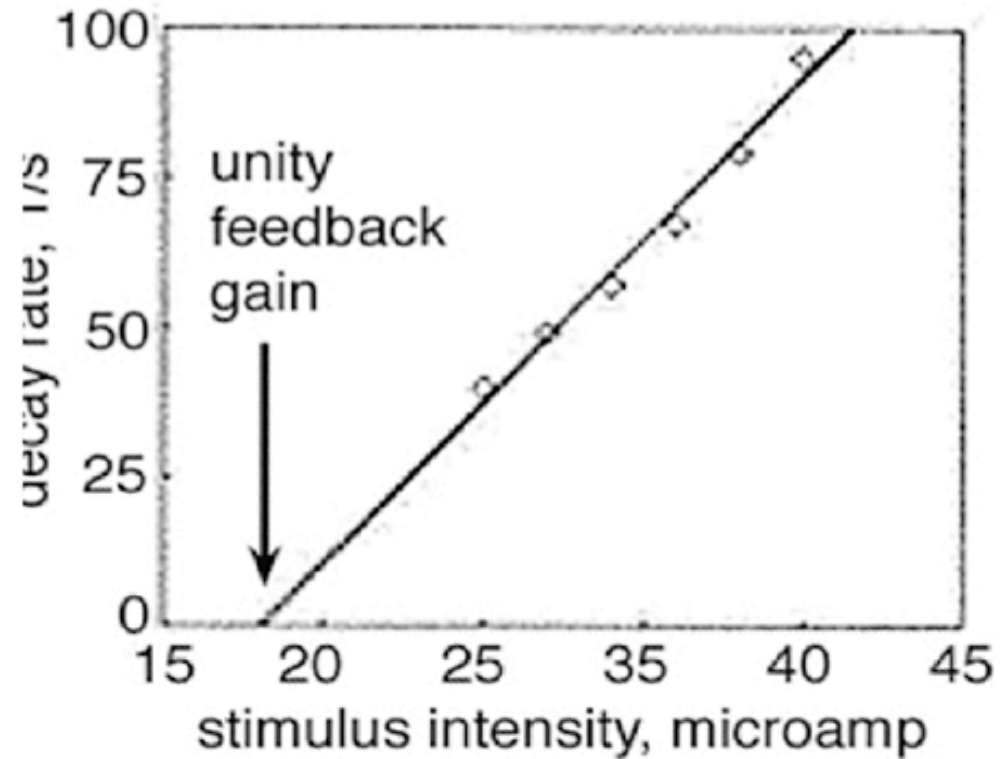
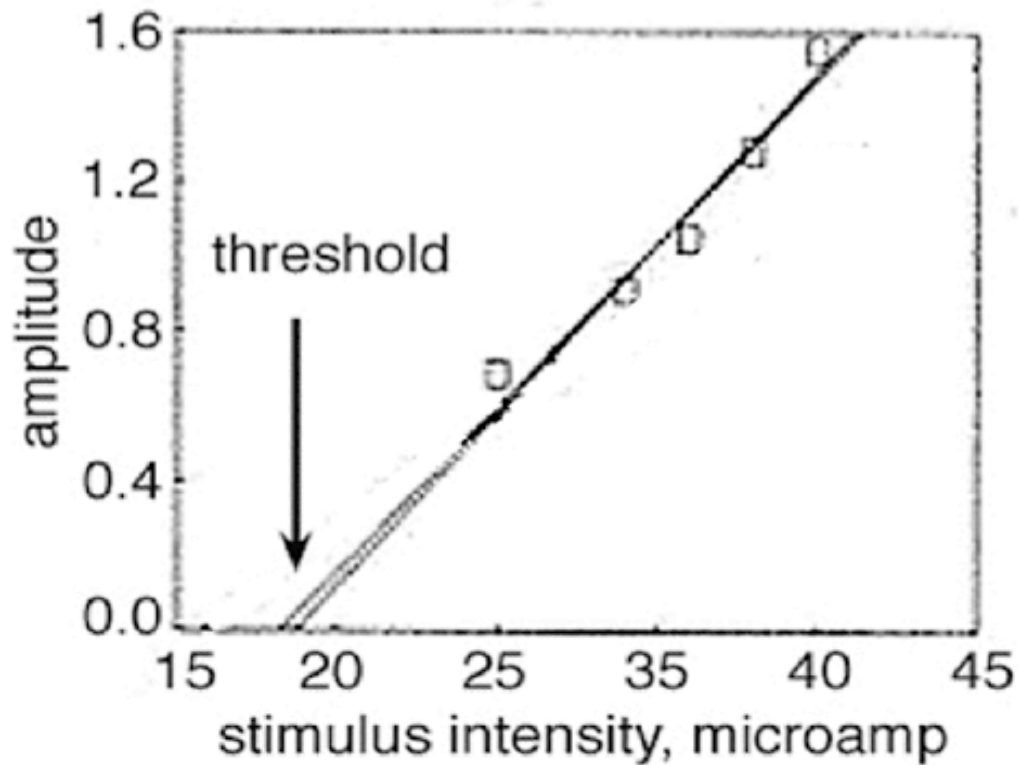

With decreasing stimulus intensity, response amplitude extrapolates to zero at threshold.

With decreasing amplitude the rate of return to baseline slows to zero rate at threshold.

This result implies that mutual excitation is self-stabilizing.

Arrows show direction of change in frequency with higher amplitude.

gain = 1.0

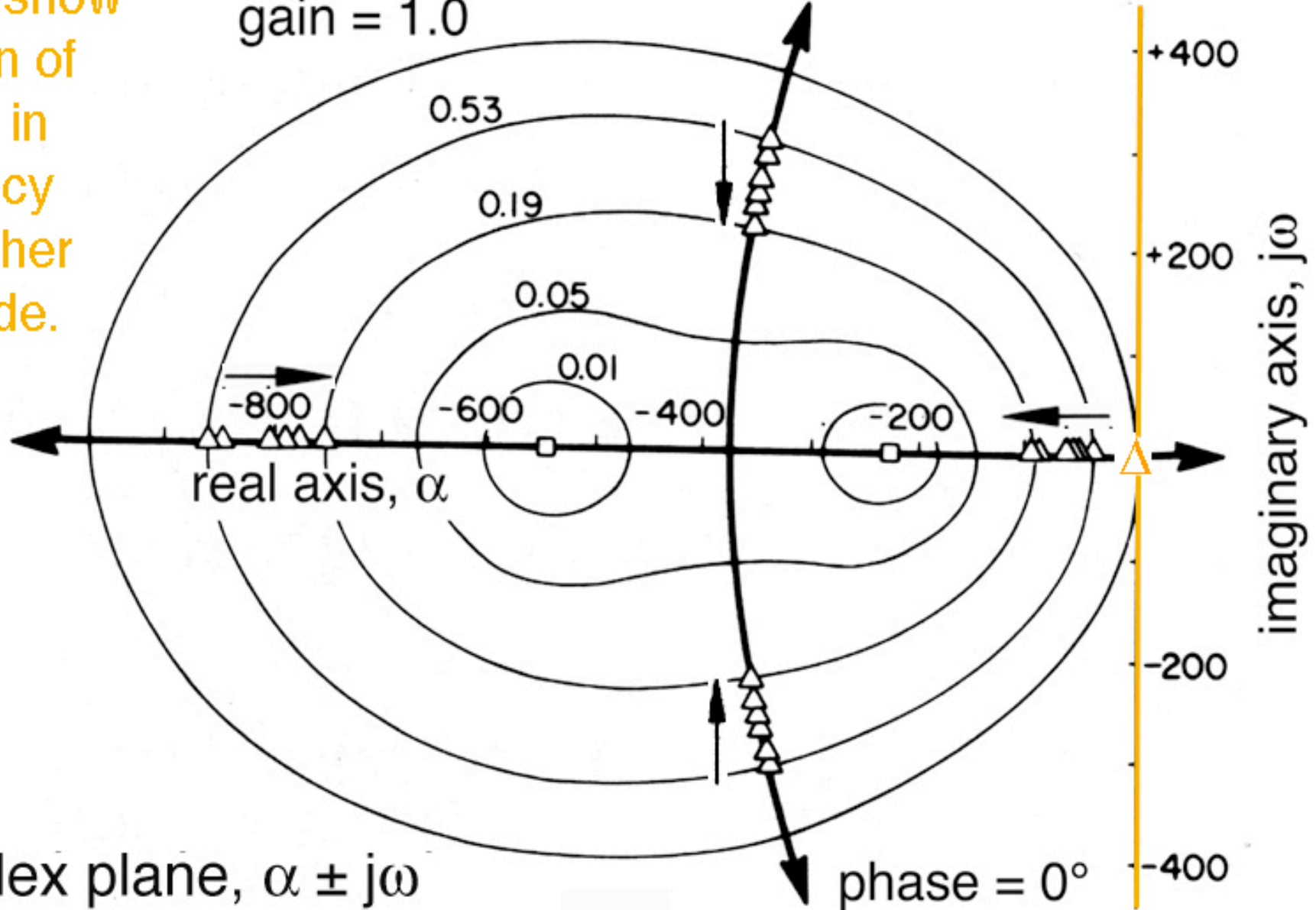

Location of the “closed loop pole”, Δ , at the origin of the complex plane, which identifies a non-zero point attractor.

What is the role of negative feedback by inhibitory interneurons?

- How do gamma AM patterns form?
- “Spontaneous” oscillations arise by negative feedback with distributed feedback delays.
- Bursts form with increased feedback gain (synaptic interaction strength) on input.

Explicit symmetry breaking by evoked activity > background activity

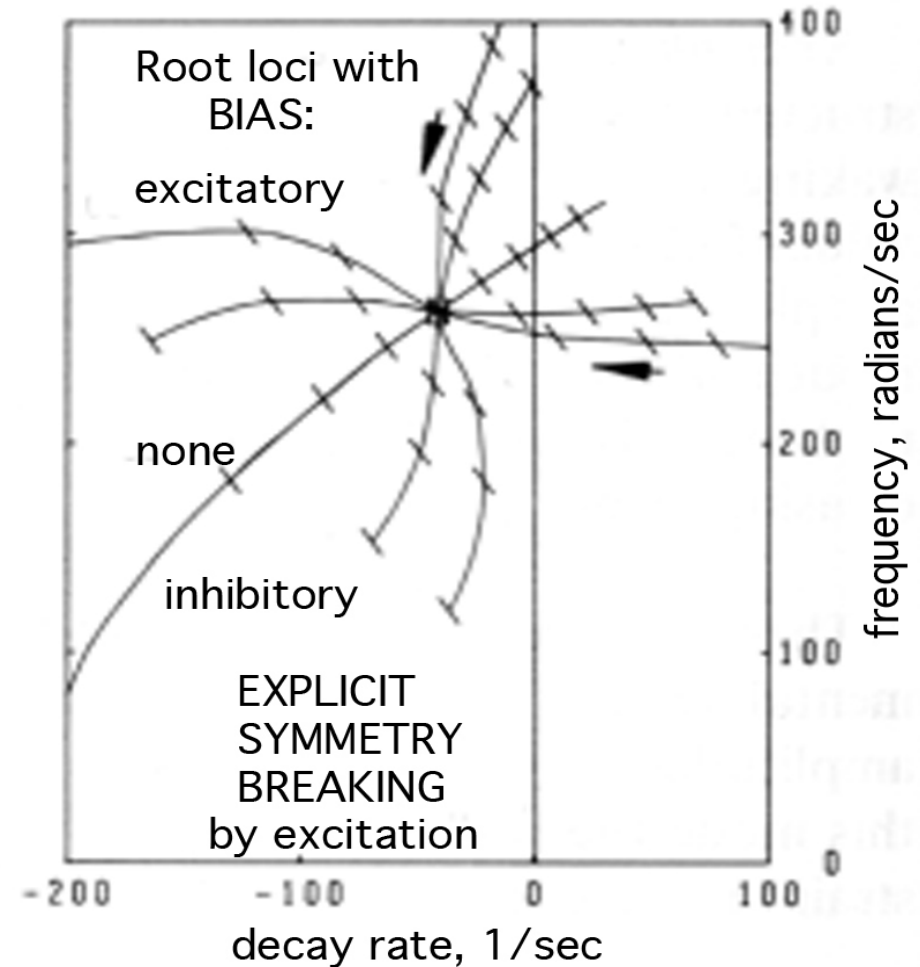
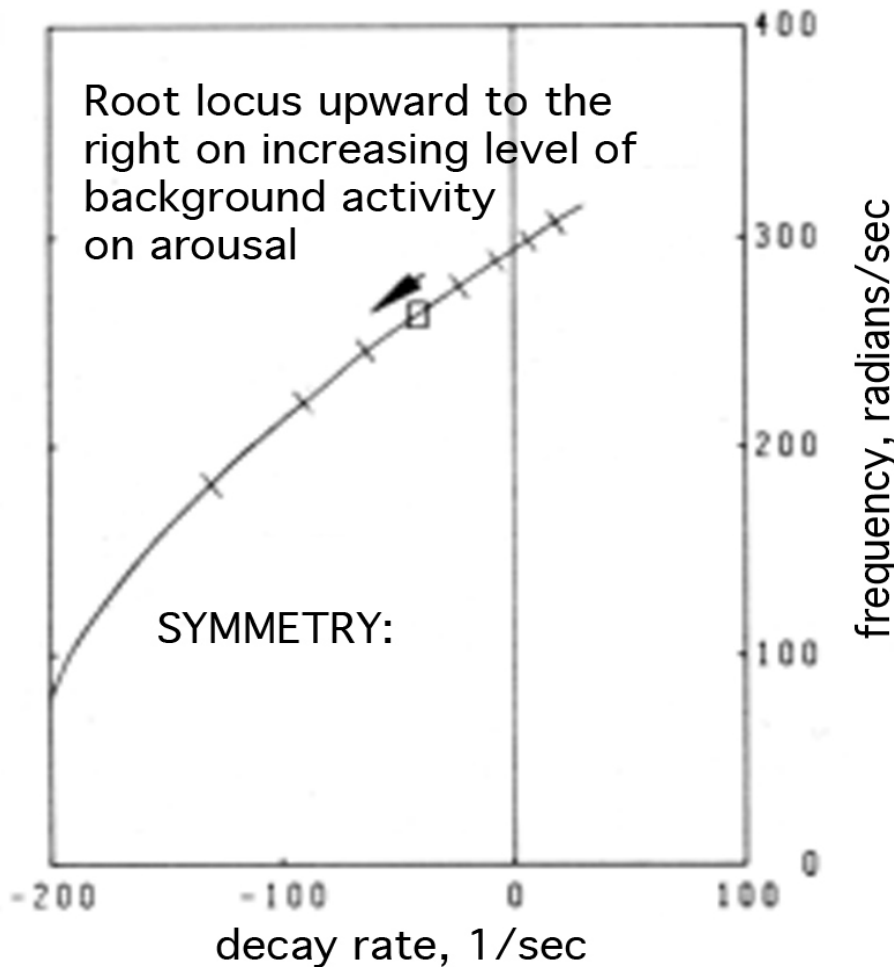

ROOT LOCI are shown for the complex conjugate pole in the upper half of the complex plane for two conditions. Left: symmetry of the three feedback gains. Right: broken symmetry. For full details see Fig 6.7, Page 360, Mass Action in the Nervous System, Freeman, 1975

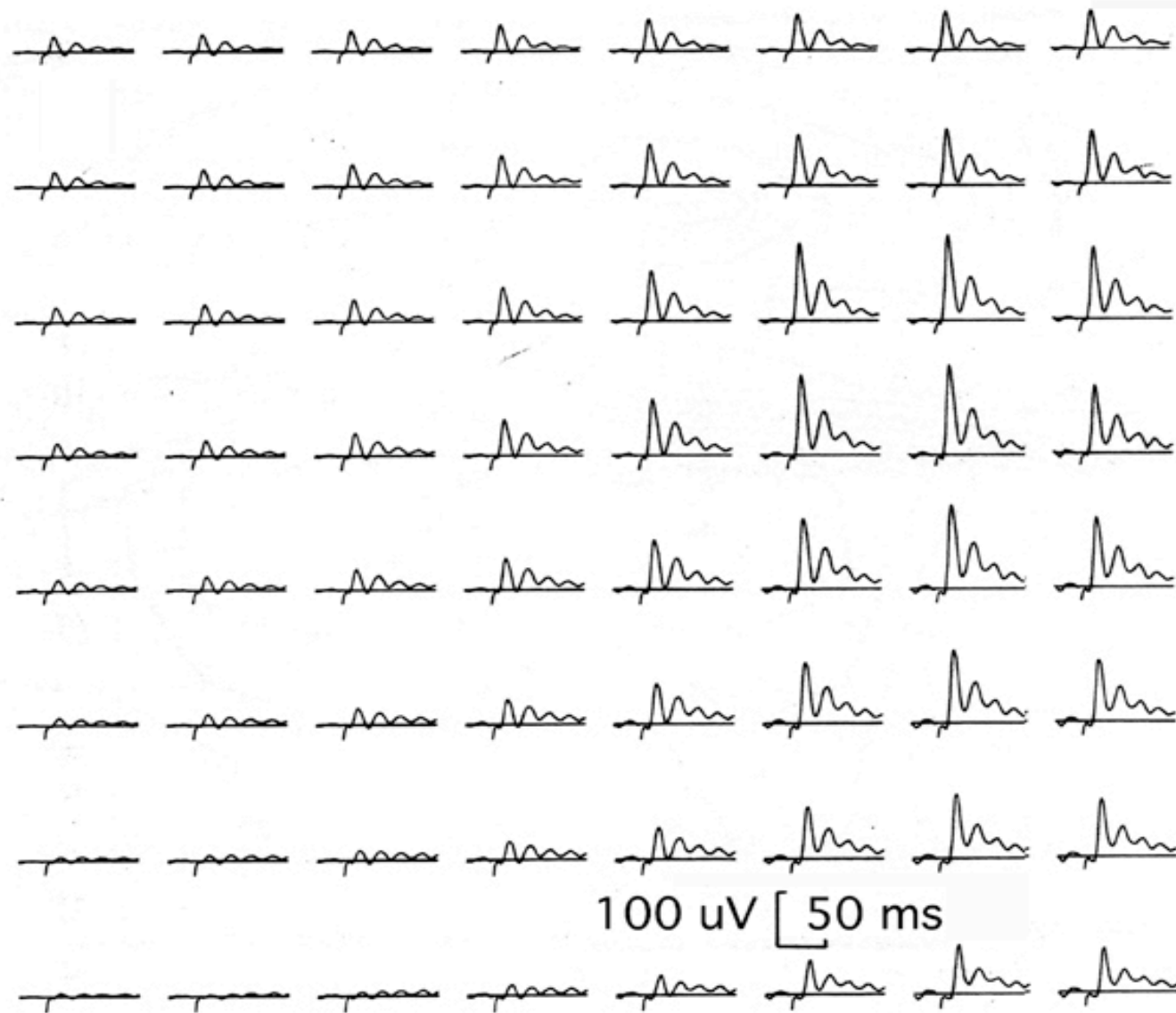

Oscillatory averaged evoked potentials (N = 100) on single shock stimulation of primary olfactory nerve.

upper half
of
complex
plane,
 $\alpha \pm j\omega$

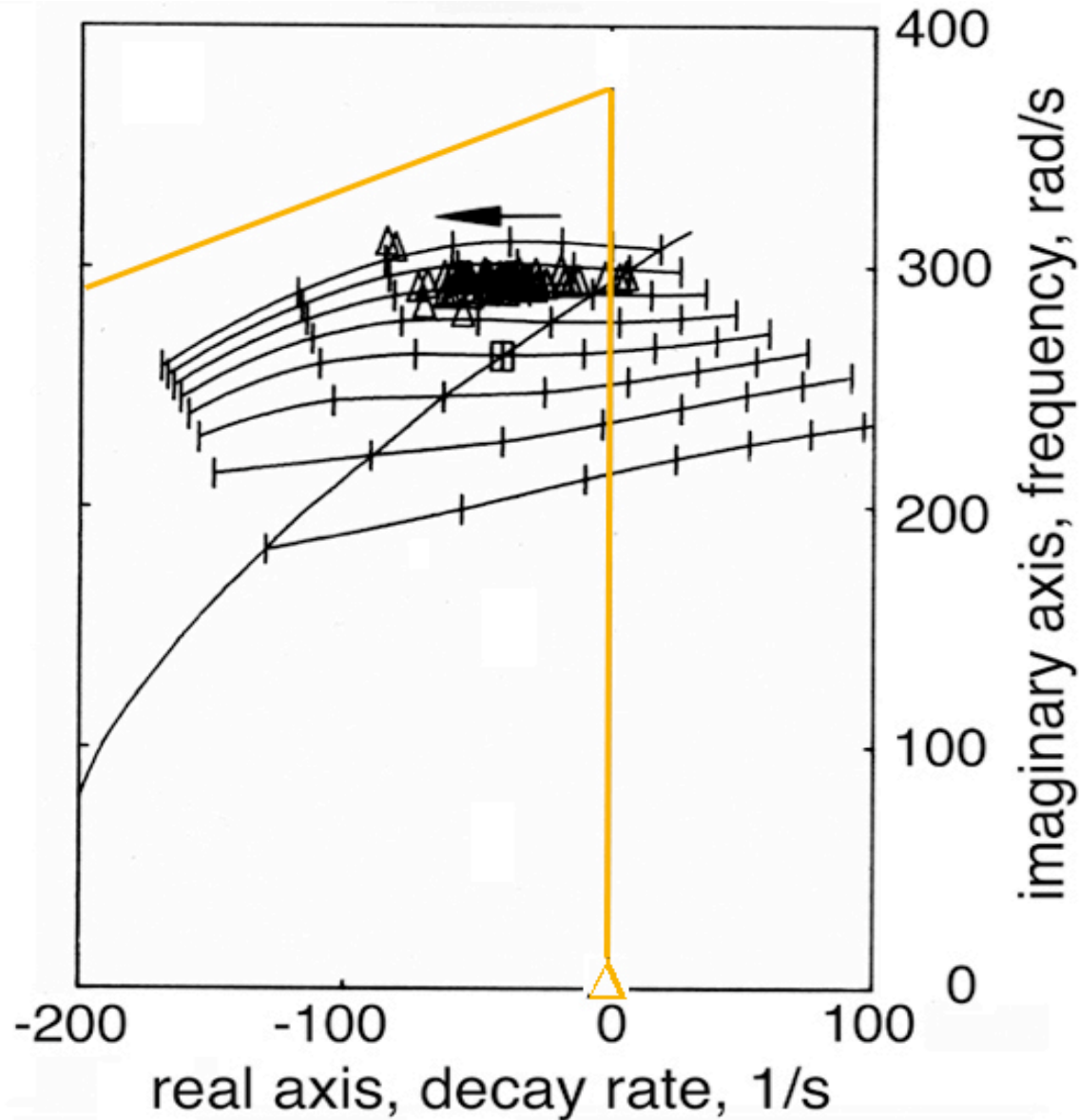

The decay rate, α , decreases in proportion to amplitude, but the frequency of oscillation, ω , is constant.

Mode 2 holds only when evoked activity < background.

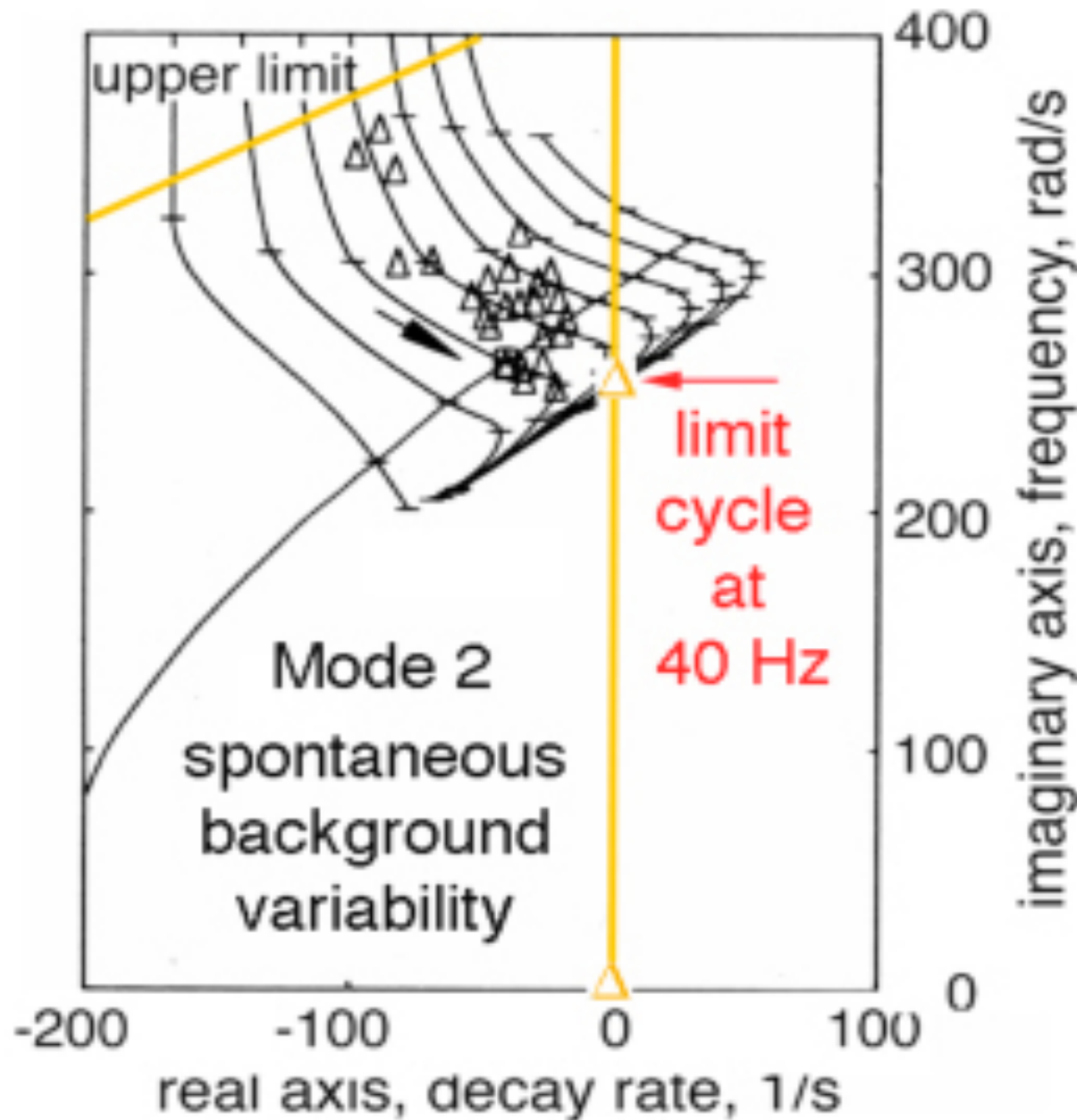

With increasing amplitude, the decay rate decreases = diminished stability.

If the trajectory crosses the imaginary axis, the approach to the limit cycle attractor leads to a singularity and phase transition.

Spontaneous symmetry breaking leads to percept formation.

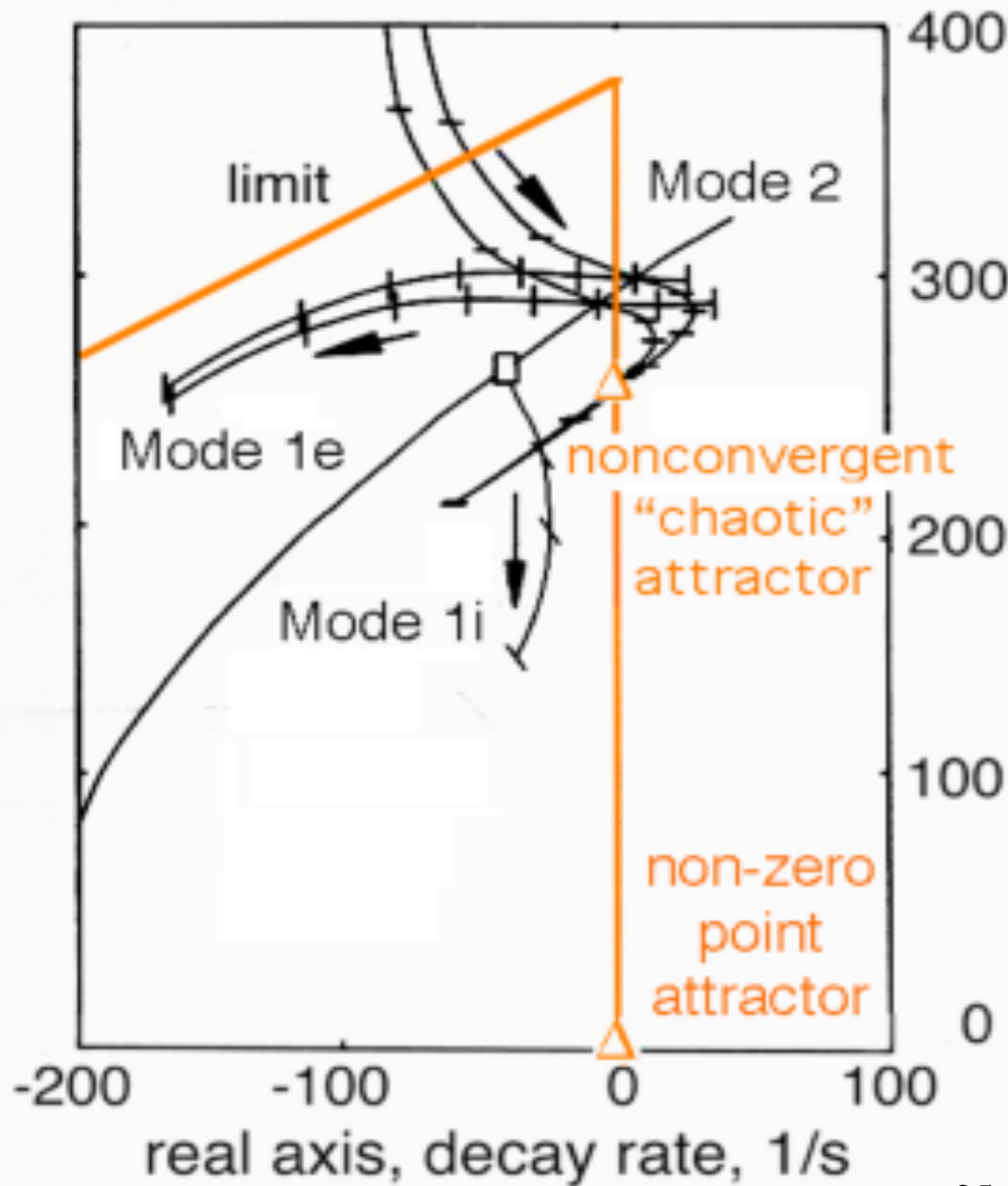

Mode 2: $K_n > 1$

Conditional stability
by nonlinear gain

Mode 1e: $K_n = 1$

Limit by refractory periods

Mode 1i: $K_n < 1$

Limit by thresholds

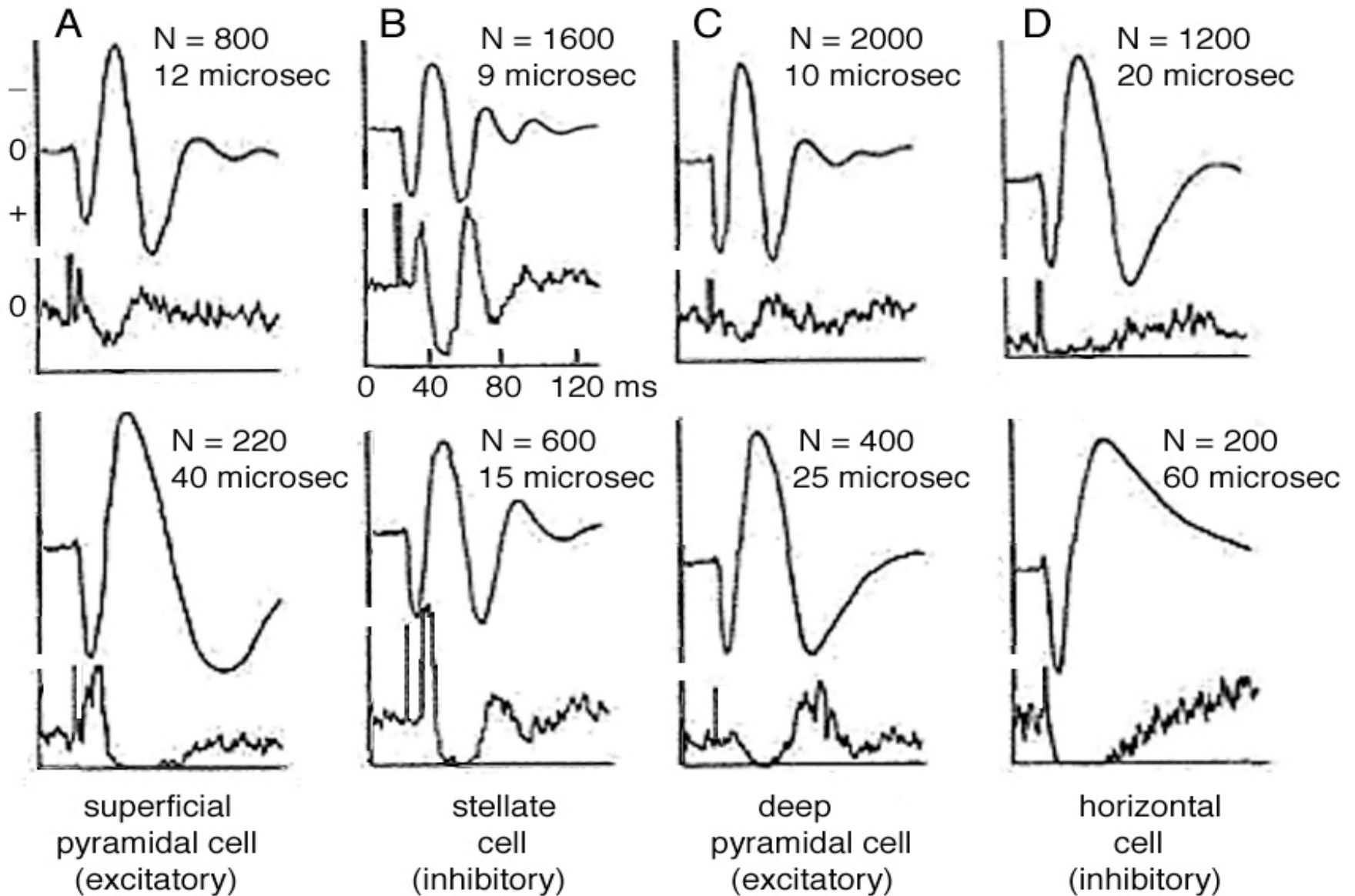

recorded from prepyriform cortex on stimulation of lateral olfactory tract, fixed 180 microamp

Poststimulus time histograms and evoked potentials: block by threshold.

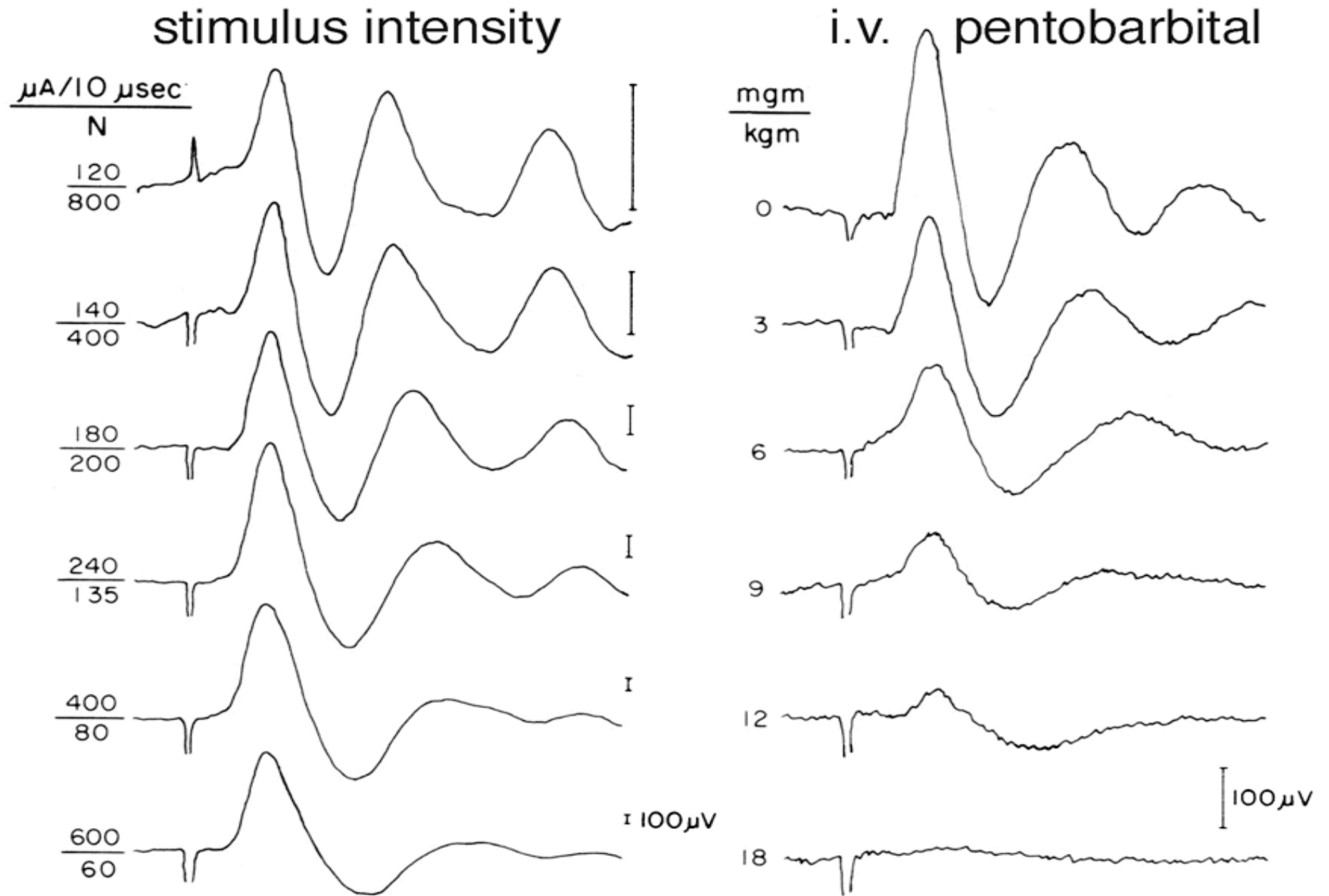

Threshold block reduces the feedback gain, thus reduces the frequency.

Transition to seizure by explicit symmetry breaking on collapse of excitation.

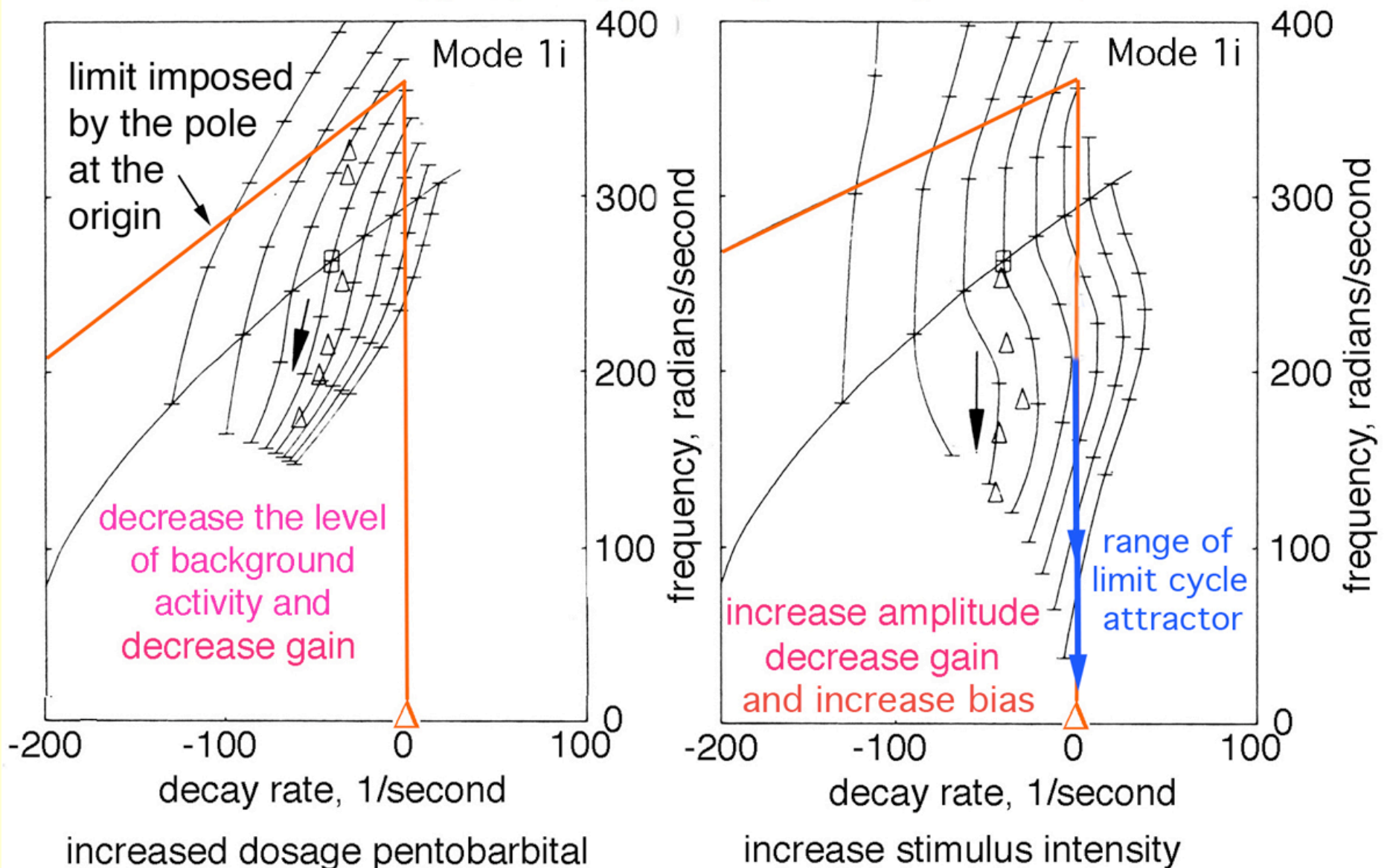

The shift of the operating point along the root locus is determined by the ratio of evoked activity to the background activity.

Electric stimulus, 10/second

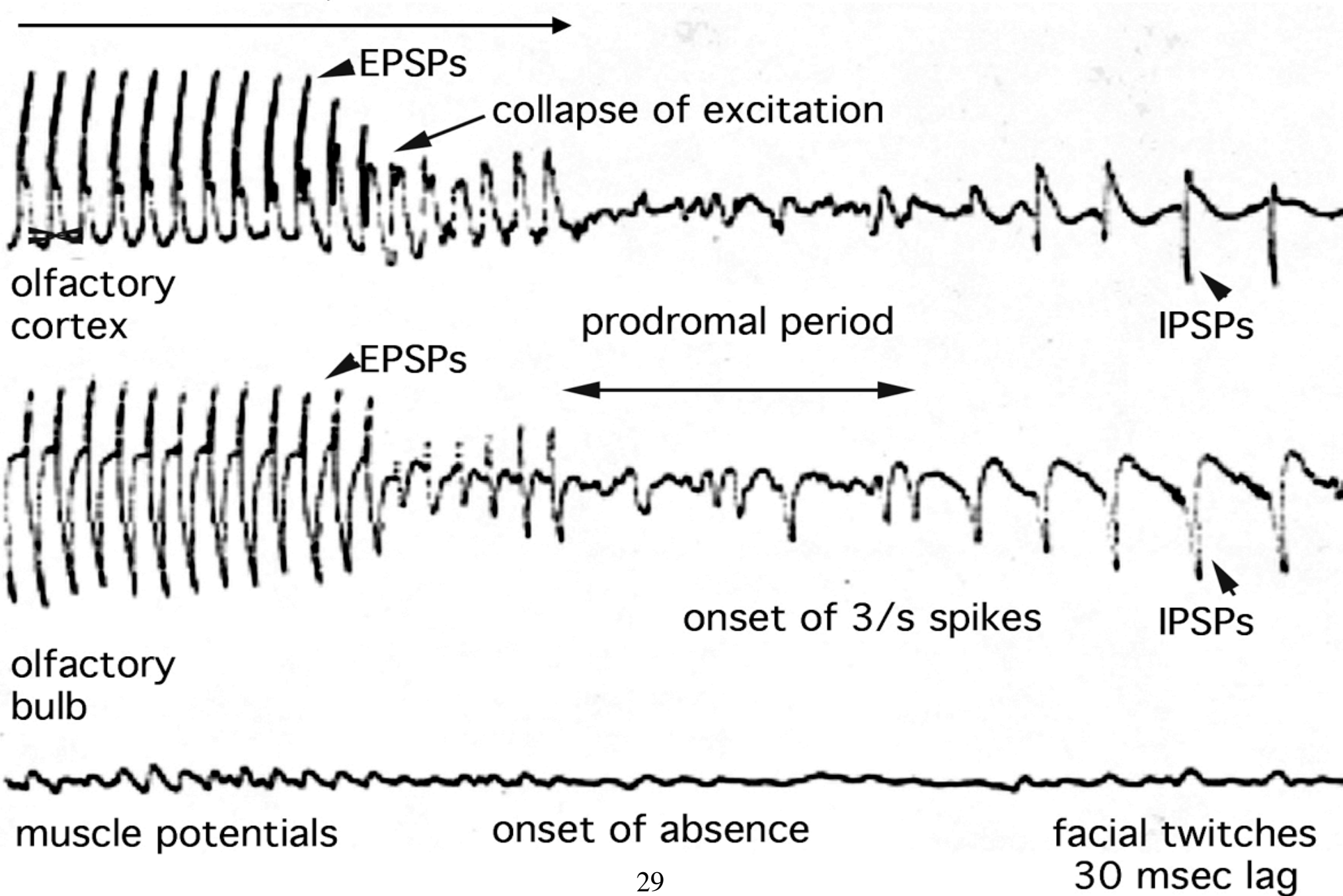

Solid curve: field potential, excitatory neurons. Dotted curve: PSTH (spikes)

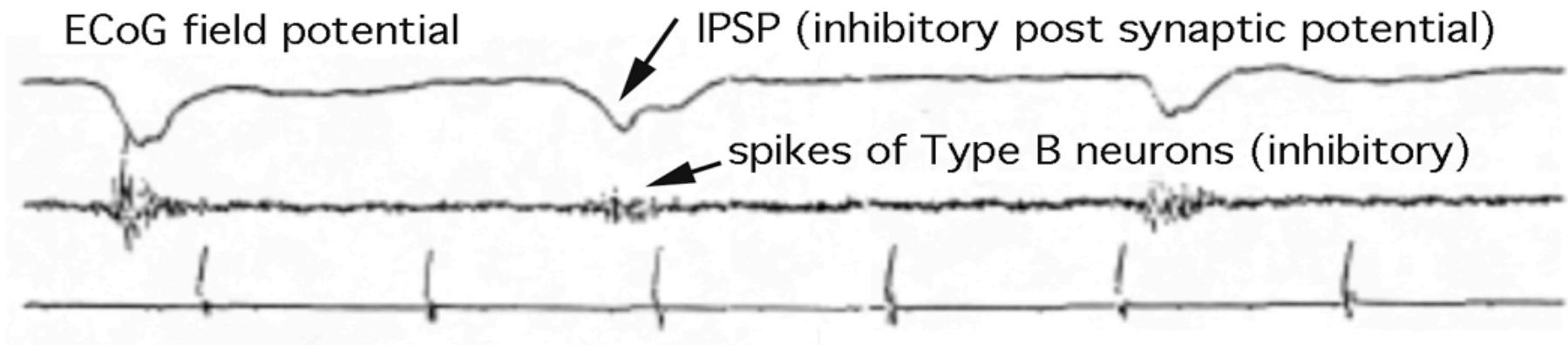
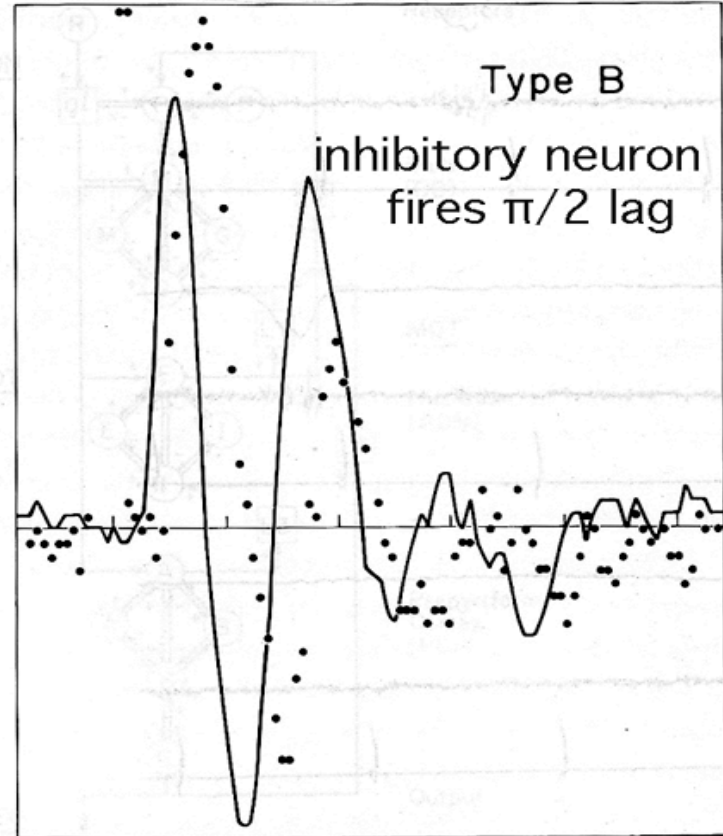
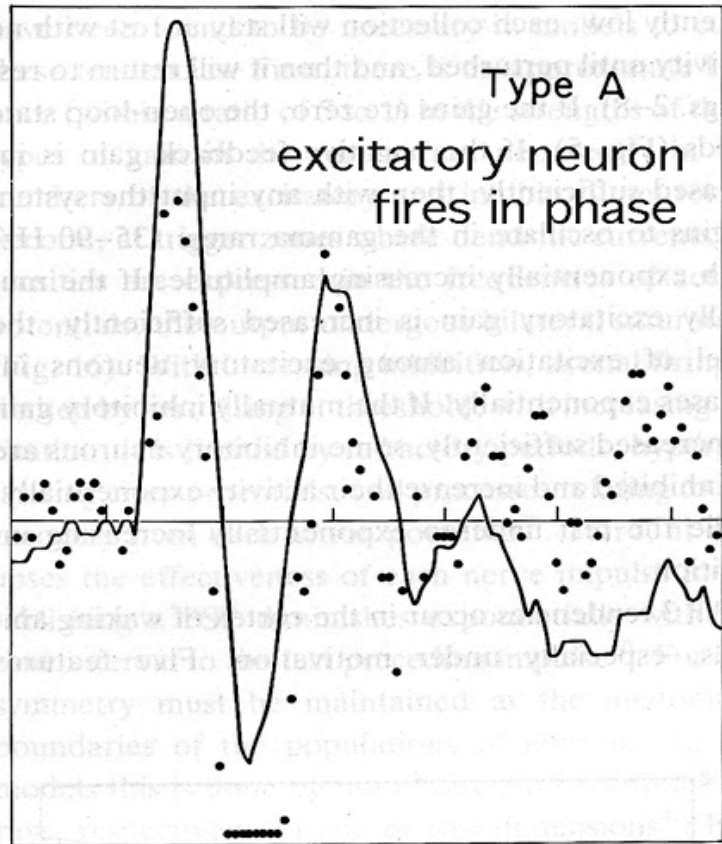

30 time marker, 100 msec intervals

Conclusions – normal function

- The brain is an open, dissipative thermodynamic system that continually creates itself by repetitive phase transitions.
- Spontaneous activity is by positive feedback - mutual excitation – that is stabilized by refractory periods, giving a point attractor.
- Inhibition provides negative feedback that sustains scale-free broad-band oscillations and maintains a limit cycle attractor.
- The three feedback gains – excitation, inhibition, negative feedback – are normally equal, maintaining a state of symmetry.
- Perception is by spontaneous symmetry breaking under controlled excitatory input from sensory receptors.

Conclusions – epileptic function

- Experimentally, complex partial seizures are triggered in the olfactory system by strong excitation to the point of transmitter depletion, which is shown by the collapse of an EPSP.
- The driven activity of inhibitory interneurons creates an explicit symmetry breaking in runaway inhibition, which is shown by an IPSP of the excitatory neurons repeating at 3/sec.
- This implies that the seizure results from an instability that emerges in a KII neural population that has been bombarded by an excess excitation that suddenly collapses.
- The IPSPs are evidence for excessive positive feedback gain among the mutually inhibitory neurons.

Clinical use of Neurodynamic Theory

1. Prevention of seizure onset

The runaway inhibition implies that seizure prevention is best done first by removing the source of abnormal excitation, and then by use of GABA blockers such as Na valproate to reduce abnormal inhibitory activity and/or inhibitory bias.

Before seizure onset, the diameter of cooperativity decreases, as predicted.

Stable cone parameters (mean \pm SD)

State		phase gradient	phase velocity	cone diameter
signal	time	γ (rad/mm)	B(m/s)	Dx(mm)
task		0.0458 \pm 0.0234	2.2253 \pm 1.2567	35.3042 \pm 18.1658
awake		0.0472 \pm 0.0232	2.1760 \pm 1.2436	36.0946 \pm 20.7945
sleep		0.0396 \pm 0.0230	2.4416 \pm 1.4054	42.9158 \pm 25.1332
Pre-1	-15	0.0626 \pm 0.0166	1.5998 \pm 0.5832	26.4534 \pm 8.6501
Pre-2	-5	0.0562 \pm 0.0299	1.5440 \pm 0.4554	24.8704 \pm 5.2128
Seizure-2	+15	0.0632 \pm 0.0211	1.4547 \pm 0.4246	24.1608 \pm 7.1592

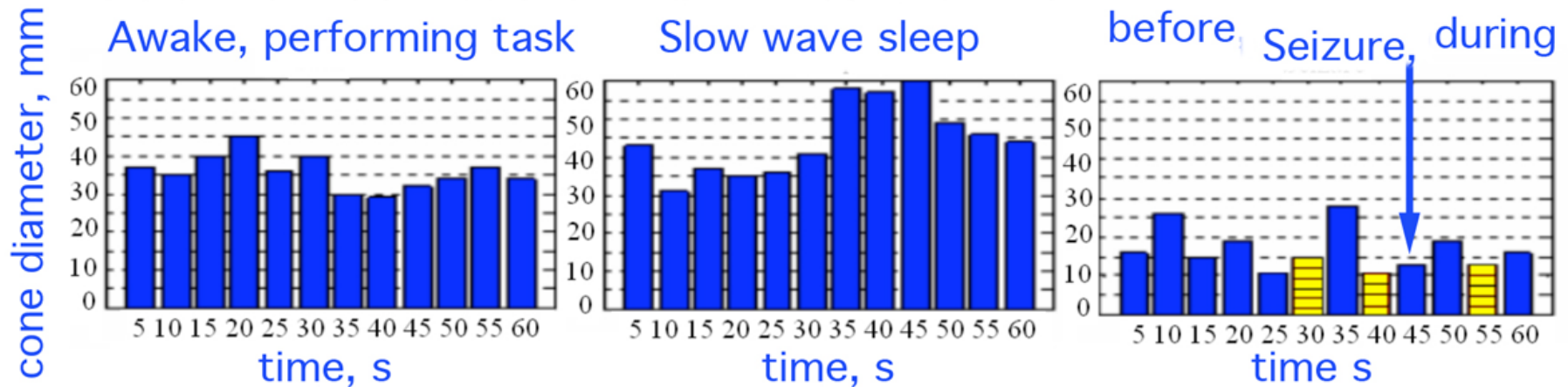

Ruiz YG, Guang L, Freeman WJ, Moreira EG. (2007) A New Approach to Detect Stable Phase Structure in High Density EEG Signals in *The 1st Intern. Conf. Cognitive Neurodynamics*. Shanghai, China: Springer, Ch. 128, pp. 741-745.

Clinical use of Neurodynamic Theory

2. Prediction of seizure onset

Measure the phase gradient,
calculate the phase velocity, and
calculate the phase cone diameter.

That index of the degree of inhibitory
bias predicts the likely onset of a
complex partial seizure at least
a minute before onset.

Methods: Four patients with medically refractory epilepsy comprise the series. In all cases definite localization of epileptic seizures was established from intracranial EEG recordings. A minute long interictal scalp EEG was selected for analysis. All samples were at least 2 hours distant from an electrographic seizure and there were no interictal epileptiform discharges. Data were imported in Matlab. Excessively noisy channels were eliminated by replacing them with the averages of their neighbors. Data were collected with 250 samples/sec. Data were filtered in theta (4-7 Hz), alpha (7-12 Hz), beta (13-30 Hz) and low gamma (30-50 Hz) bands.

Holmes, Ramon, Freeman, 2008.
Relation of phase
synchronization index to
epileptogenic regions of cortex.

American Epilepsy Society
5-9 December 2008
Seattle WA, USA

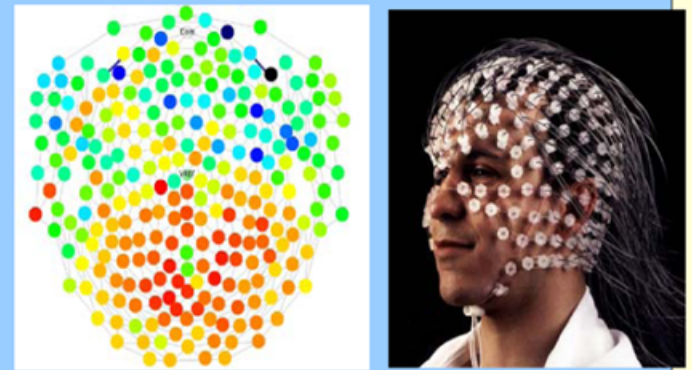

256 Channel EEG data
collection. (Left) electrode
layout, (right) Electrode net on a
subject.

Results: In all four cases, electrode plots revealed regions of maximal LRTC of phase synchronization index (SI) that closely matched with the invasive localizations. However, LRTC of scalp EEG did not show such a good match with invasive localizations. For one patient, results in all bands are given below. LRTC: Long Range Temporal Correlation SI: synchrony index

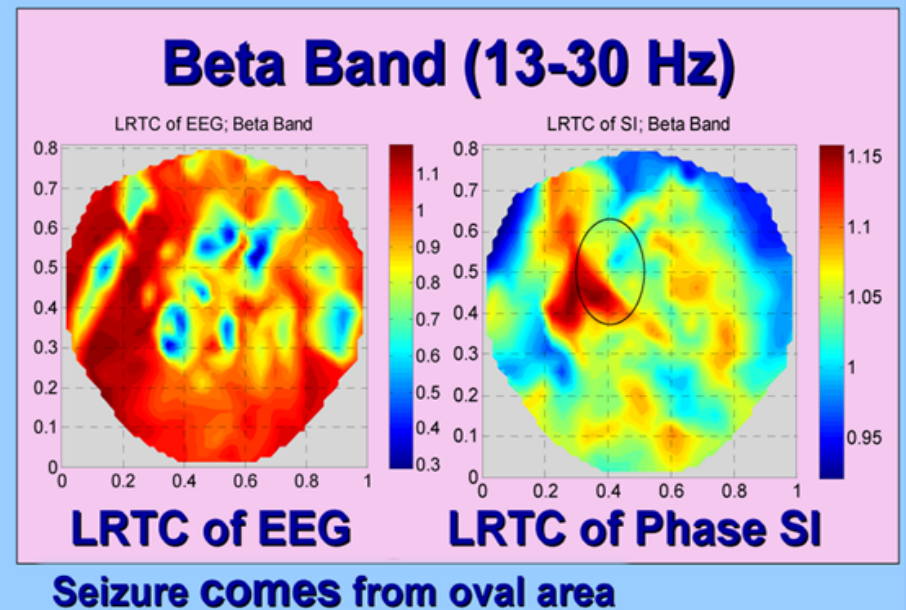
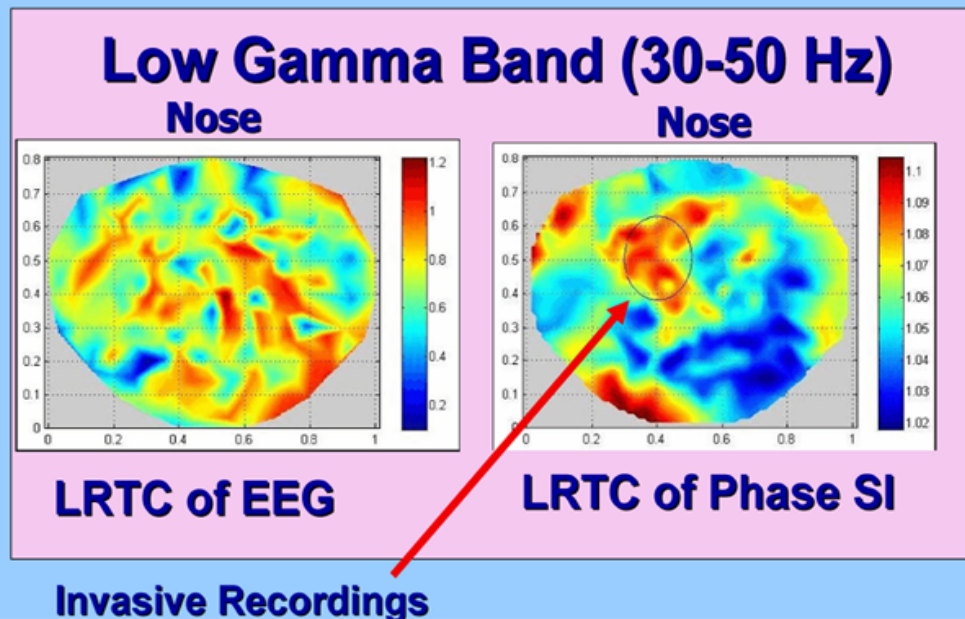

Holmes MD, Ramon C, Freeman WJ (2008) Correlation of phase synchronization in high density interictal scalp EEG: Relationship to epileptogenic regions. Amer. Epilepsy Soc, 5-9 Dec 2008, Seattle WA.

Clinical use of Neurodynamic Theory

3. Prediction of seizure location

Calculate EEG analytic phase for six nearest neighbors of each channel and average for the synchronization index (SI) at every channel.

The plots of the SI for scalp EEG from 256 channels show hot spots at locations that are identified as seizure sites by invasive recording.

Engineering References

- Freeman WJ (1975) Mass Action in the Nervous System. New York, Academic. <http://sulcus.berkeley.edu/MANSWWW.html>
- Freeman WJ (1986) Petit mal seizure spikes in olfactory bulb and cortex caused by runaway inhibition after exhaustion of excitation. Brain Research Reviews 11:259-284.
- Siklós L, Rickmann M, Joó F, Freeman WJ, Wolff JR (1995) Chloride is preferentially accumulated in a subpopulation of dendrites and periglomerular cells of the main olfactory bulb in adult rats. Neuroscience 64: 165-172.
- Freeman, WJ, Vitiello G (2007) The dissipative quantum model of brain and laboratory observations. Electronic J Theoretical Physics 4, 1-18. <http://dx.doi.org/10.1016/j.plrev.2006.02.001>
- Freeman WJ [2008] A pseudo-equilibrium thermodynamic model of information processing in nonlinear brain dynamics. Neural Networks 21: 257-265. <http://repositories.cdlib.org/postprints/2781>

Biological References

- Freeman WJ [2004a] Origin, structure, and role of background EEG activity. Part 1. Analytic amplitude. Clin. Neurophysiol. 115: 2077-2088. Part 2. Analytic phase. Clin. Neurophysiol. 115: 2089-2107. <http://repositories.cdlib.org/postprints/1006>, <http://repositories.cdlib.org/postprints/987>.
- Freeman WJ, Holmes MD, West GA, Vanhatalo S [2006] Fine spatiotemporal structure of phase in human EEG. Clin. Neurophysiol. 117(6): 1228-1243.
- Freeman WJ, Holmes MD, West GA, Vanhatalo S [2006] Dynamics of human neocortex that optimizes its stability and flexibility. Intern. J. Intelligent Syst. 21: 1-21. <http://repositories.cdlib.org/postprints/2385>
- Ruiz YG, Guang L, Freeman WJ, Moreira EG. [2007] A New Approach to Detect Stable Phase Structure in High Density EEG Signals in *The 1st Intern Conf Cogn Neurodyn*. 2007. Shanghai, PRC: Springer, Ch. 128, pp. 741-745.
- Ramon C, Holmes MD, Freeman WJ, McElroy R, Rezmanian E [2008] Comparative analysis of EEG and phase synchronization of EEG to localize epileptic sites from high density scalp EEG interictal recordings. Abstract, Engineering in Medicine and Biology EMBS, Bimag2008, Japan
- Holmes MD, Ramon C, Freeman WJ (2008) Correlation of phase synchronization in high density interictal scalp EEG: Relationship to epileptogenic regions. Amer. Epilepsy Soc, 5-9 Dec 2008, Seattle WA, USA.